



Sectional garage doors

NEW: Certified RC 2 security equipment, as standard with the LPU 67 Thermo

HÖRMANN





CONTENT

6	Good reasons to try Hörmann
16	Overview of steel sectional doors
18	Door styles
32	Individual design styles
34	Door design
42	Overview of steel sectional doors
44	Solid timber sectional doors
48	Glazed aluminium frame doors
50	Overview of solid timber sectional doors
51	Overview of aluminium frame doors
52	Individual sectional doors
54	Technology
56	Special equipment
58	Handles / release
59	Glazings
60	Wicket doors
62	Side doors
64	Hinged garage door DFT 42
66	Performance characteristics / ThermoFrame
68	Garage door operators
72	Accessories
76	Modernise and improve
82	Dimensions and fitting data
86	Hörmann product range

Some of the doors shown are equipped with optional extras and do not always correspond to the standard versions.

The surface finishes and colours shown are subject to the limitations of the printing process and cannot be regarded as binding.

All rights reserved. No part may be reproduced without our prior permission. Subject to changes.

Benefit from numerous advantages

Sectional doors open vertically upwards and are suspended under the ceiling to save space. This construction principle means you can make full use of the space inside and in front of the garage. Sectional garage doors can be fitted in any garage opening and offer up to 14 cm more passage width than up-and-over doors. They are also optimally sealed with flexible and weather-resistant seals on all four sides.

Treat yourself to this comfort and convenience.





“A good reputation must be earned.”

August Hörmann

In keeping with the tradition started by the company's founder, the Hörmann brand today is a true promise of quality. The family-owned company has over 80 years of experience in door and operator construction and, with sales of over 20 million doors, is no. 1 in Europe. This makes a Hörmann sectional door a reassuring purchase.



1 Made in Germany

All essential doors and operator components are developed and manufactured by Hörmann, are **perfectly matched to each other** and **tested and certified** by independent, recognised institutes to ensure your safety. They are manufactured in Germany according to the DIN ISO 9001 quality management system and meet the requirements of European standard 13241. Furthermore, our highly qualified employees work intensively on new products, continual further developments and improvements to details. The results are patents and unique products on the market.

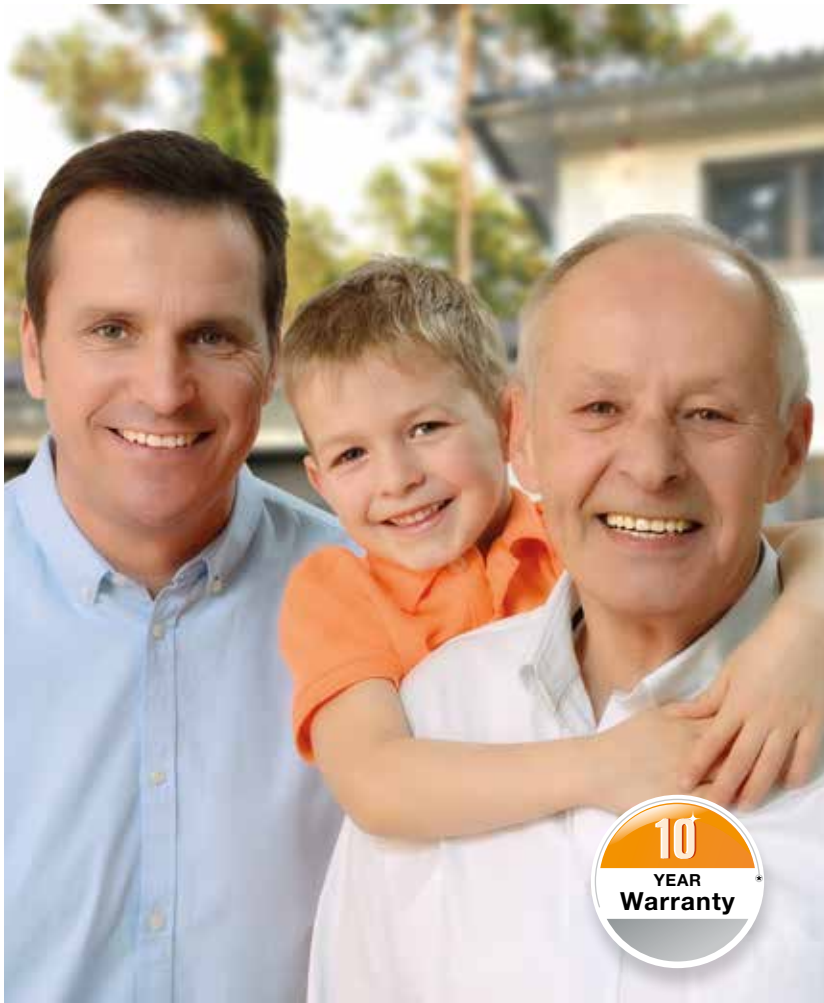

2 Brand quality for generations

Endurance tests under real conditions ensure mature series products with Hörmann quality. Thanks to this, as well as excellent technical solutions and uncompromising quality assurance, you receive a **10-year warranty on all Hörmann sectional doors, a 5-year warranty on Duragrain and Decograin surface finishes and a 5-year warranty on Hörmann operators.***

* The complete warranty conditions can be found at: www.hormann.co.uk

3 An eye on the future

Hörmann is setting a good example. This is why the company obtains **100% of its energy consumption from green sources**. Together with an intelligent and certified energy management system, CO₂-neutral mailing and the recycling of valuable materials, **more than 40000 tons of CO₂ are saved each year**. And last but not least, Hörmann also offers products for sustainable construction.

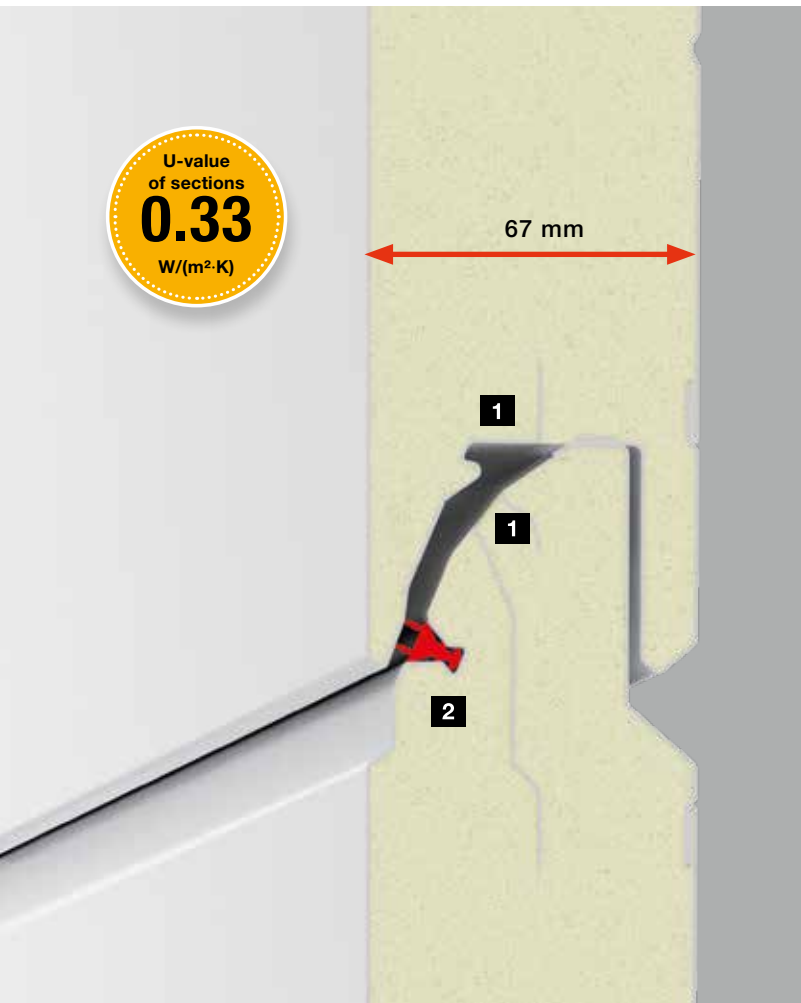

4 Modern energy-saving door

Double-skinned sectional doors are particularly recommended for garages attached directly to the house. In addition to the LPU 42 with very good thermal insulation, the **LPU 67 Thermo** offers everything that is expected from modern construction: **excellent thermal insulation achieved by sections with a thermal break 1** with a U-value of $0.33 \text{ W}/(\text{m}^2 \cdot \text{K})^*$, a very good seal on spaces between sections with double lip seals **2** and an optimum floor connection using double bottom seals, which also compensates for floor unevenness and energy losses.

* U-value of door (5000 × 2125 mm): $1.0 \text{ W}/(\text{m}^2 \cdot \text{K})$

5 Efficient thermal insulation

! Only from Hörmann

With the **Hörmann ThermoFrame** you can improve the already high insulation values of double-skinned sectional doors. The black plastic profile is fitted together with the door frame. **Insulation is improved by 15%**** thanks to the thermal break between the frame and brickwork. The ThermoFrame frame connection is optionally available for all Hörmann sectional doors.

For further information, see page 66.

** For a double-skinned sectional garage door LPU 42 with the dimensions 5000 × 2125 mm



6 Optimum long-term protection

! Only from Hörmann

A non-brittle, 4 cm **plastic frame shoe** covers the frame where it is prone to rusting and offers **long-term protection against corrosion**, even with waterlogging, which is unmatched by competitor solutions. Together with the door's bottom seal, the frame shoe makes for a bottom edge that is visually appealing.

7 Permanently beautiful Duragrain decors

! Only from Hörmann with high-strength protective coating

The new Duragrain surface finish with 24 decors impresses with a **detailed, natural and colourfast door view**. An innovative **digital printing 1** on the **primer 2** of the **galvanized section 3** and a **final high-strength protective coating 4** ensure a permanently beautiful door view. The optional lintel and frame fascias are supplied in a colour matching the decor.

For further information, see pages 40 – 41.

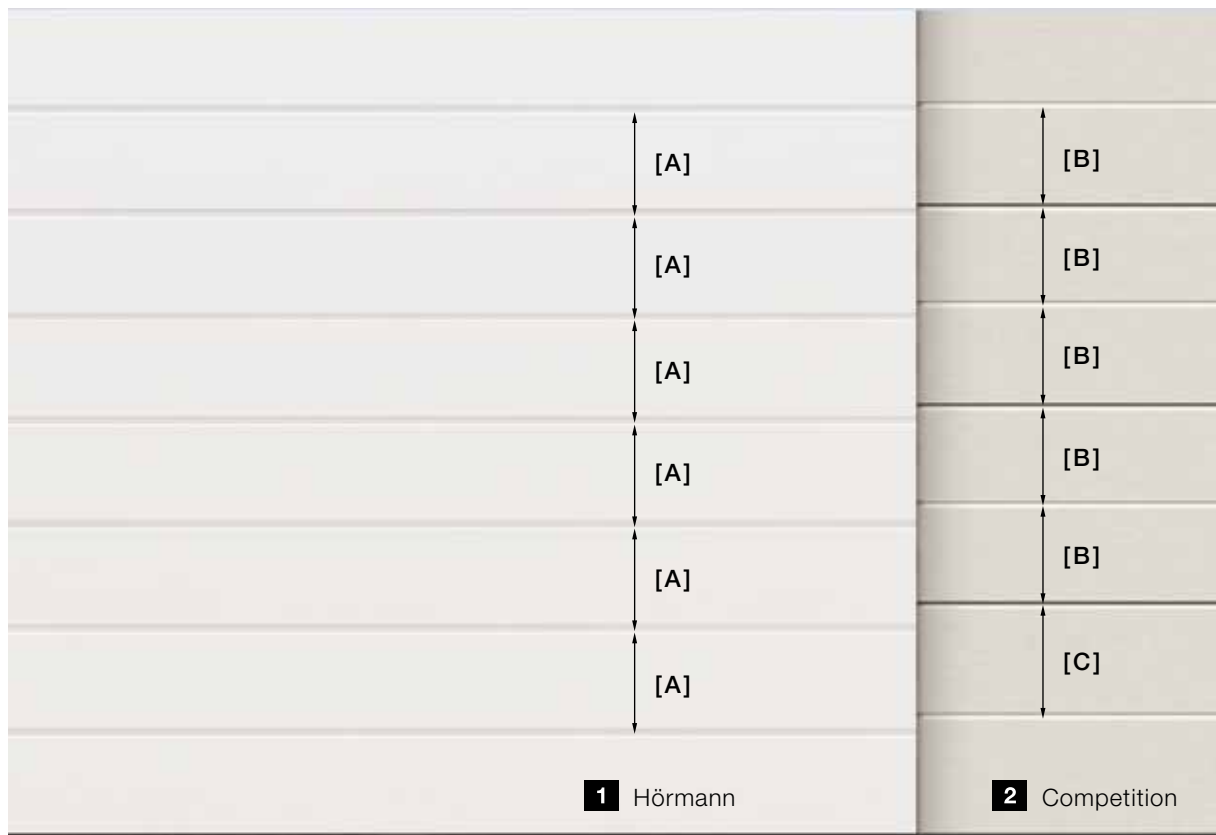

8 A harmonious overall appearance

Only from Hörmann in all door sizes

1 Even spacing and invisible section transitions for ribbed doors

Hörmann garage doors are distinguished by even, exact spacing of sections [A]. The sections are shaped so that the transitions are practically invisible when the door is closed. See for yourself!

To add to the overall appearance, a practical side door with an alignment matching the sectional garage door is also available. For further information, see pages 62 – 63.

2 Irregular spacing of sections [B], [C] due to different section heights coupled with visible section transitions on competitor doors. This gives the door an uneven look.

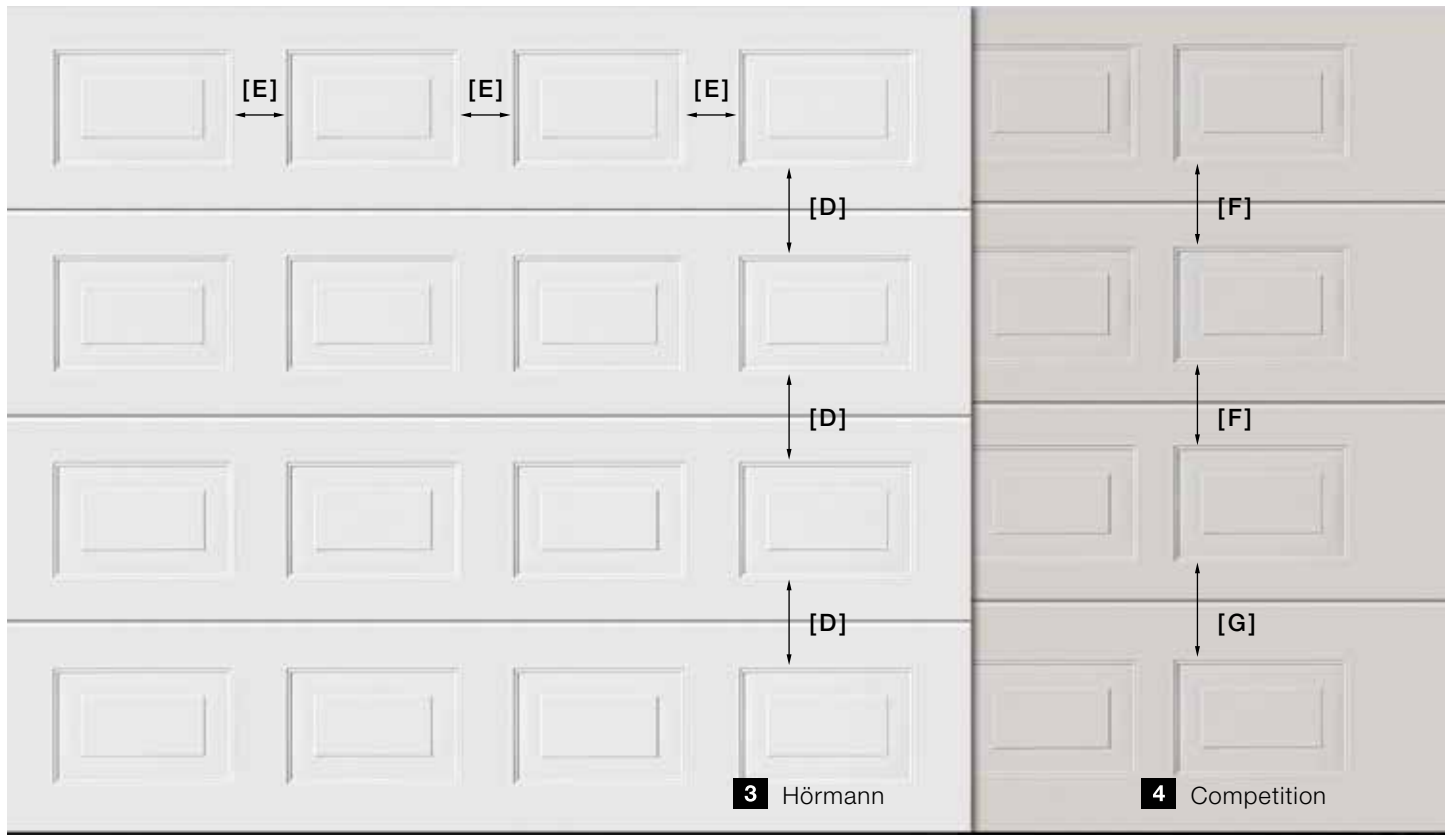

Only from Hörmann in all door sizes

3 Uniformly divided panelled doors

To create a harmonious overall appearance, the height of the spaces between the individual panels [D] of Hörmann sectional doors is exactly even. This is achieved by using sections with the same height across the entire door height. The horizontal spacing between the panels within a section [E] is also uniform. This gives the doors an even appearance.

On request, side doors are also available with the same section spacing as the sectional garage door. For further information, see pages 62 – 63.

4 Irregular panel spacing [F], [G] due to different section heights on competitor doors. This gives the door an uneven look.

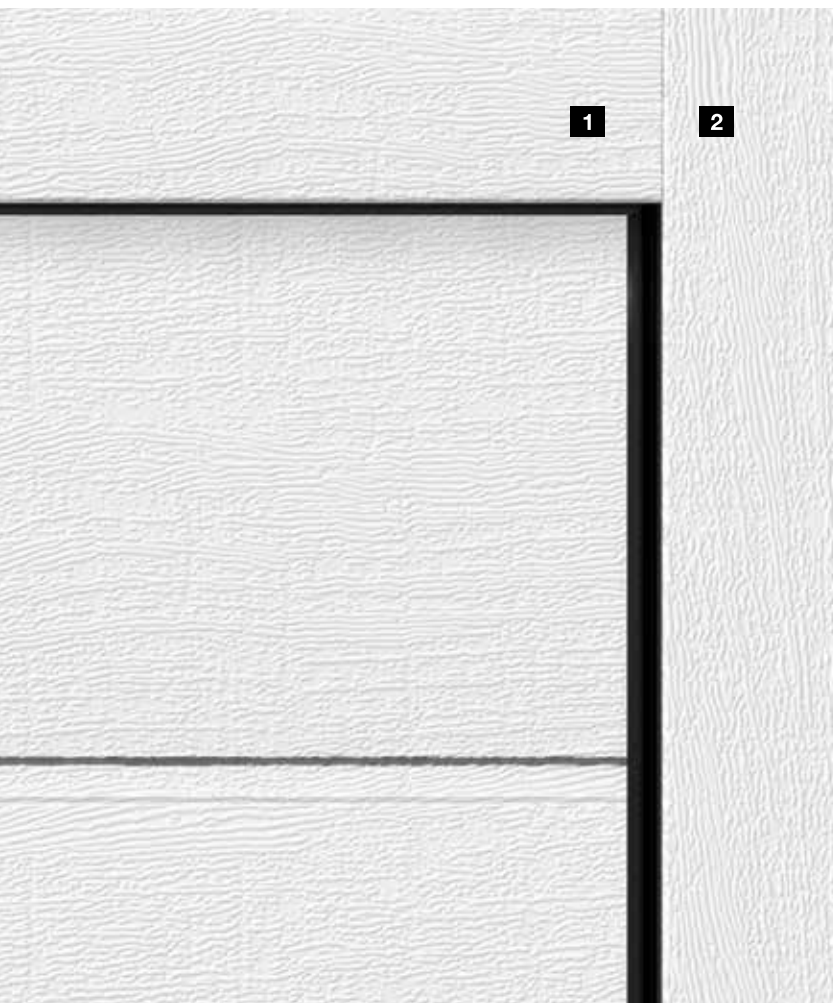

9 Matching appearance of frames and door leaves

! Only from Hörmann

The **harmonious appearance of a door** is the result of many small details: For white doors and all surface finishes, the fascia panel **1** is always provided matching the door sections. This ensures that everything fits together. The side frames **2** are available with a white Woodgrain surface finish* as standard. For sectional doors with the surface finishes Sandgrain, Silkgrain or Decograin as well as coloured doors, the frame coverings are optionally available in the surface finish of the door section. For Duragrain doors, we optionally supply the frame cladding and the panels in a colour that matches the decor.

* For the LPU 67 Thermo and LPU 42 in premium versions in Grey white RAL 9002

10 Simple pedestrian passage

In order to retrieve bicycles or gardening equipment from your garage without opening the door, the LPU 42 door with a wicket door with trip-free threshold is recommended. The clear opening width of 830 mm or 1150 mm offers a convenient passage, even for wide equipment or bicycles, motorbikes and scooters.

The stainless steel threshold is only 10 mm high in the centre and 5 mm high at the sides. This makes it easier to wheel things through and reduces the risk of tripping.

For further information, see pages 60 – 61.



11

Anti-lift kit as standard

Only from Hörmann Mechanical anti-lift kit in the operator boom

Uninvited guests barely stand a chance with Hörmann automatic sectional doors. When the garage door is closed, the **anti-lift kit** automatically engages in the guide rail stop, then **locks immediately and is secured against forced opening**. This patented door locking functions purely mechanically and, in contrast to competitor operators, continues to secure the door even when the power fails.

Take a look at the video "Garage door operators – Reassuring security" at: www.hormann.co.uk/videos

12

Certified RC 2 security equipment

The garage sectional door LPU 67 Thermo and optionally the LPU 42 come with **certified RC 2 security equipment as standard**. If you have direct access from the garage to the house, you can apply to the **KfW bank for a subsidy of 10 to 20%** for modernisation, and thereby pay **less** for an RC 2 secured door than for a door without security equipment! For further information, see page 57.



The carefully tested RC 2 security equipment is also recommended by police information centres. Further information can be found at www.k-einbruch.de



13

Certified safety



Only from Hörmann



The bi-directional BiSecur radio system is based on **future-oriented technology** for the convenient and secure operation of garage and entrance gate operators, door operators, lights and more. This extremely secure BiSecur encryption protocol, developed by Hörmann, with a stable, interference-free range makes sure that no one can copy your radio signal. It was tested and certified by security experts at Bochum university and independent test institutes.



Watch the video "BiSecur – the radio system with certified safety" at: www.hormann.co.uk/videos

14

Perfectly aligned

All BiSecur operators, receivers and control elements are 100% compatible. By simply pressing the button on your hand transmitter or radio switch, you can operate your garage door and entrance gate as well as entrance door locks, door operators or other devices with BiSecur receivers. The BiSecur control elements are suitable for the operation of all Hörmann operators with a radio frequency of 868 MHz (year of manufacture 2003 – 06/2012) / (querying the door position is not possible). **The standard HCP interface* in every Hörmann operator provides you with even more options.** It makes it easy to network all Hörmann garage and entrance gate operators with external Smart Home systems.

* HCP = Hörmann Communication Protocol



15 Convenient door query

You no longer have to go out in any wind and weather to check if your door is closed. At the press of a button, the colour of the LED on the hand transmitter HS 5 BS or the internal push button FIT 5 BS indicates the position of the door. If required, another push of a button* closes the door. It is the most convenient and secure way to control your door.

* An additional photocell is required for operation without visual contact to the door.

16 Smart app operation

Hörmann BlueSecur

Simply use your smartphone as a hand transmitter. **With the Hörmann BlueSecur app, you can conveniently operate your garage door or entrance door via Bluetooth**.** In addition, other user permissions*** can easily be permanently or temporarily transferred to other smartphones for family members. This way, every family member always has their “door and gate opener” with them on their smartphone.

** In conjunction with an internal or optional Hörmann Bluetooth receiver

*** Extra purchases (in-app purchases) in the AppStore or Google Play may be required



Display on hand transmitter HS 5 BS

- 1** Door is opened
- 2** Door is closed

LPU 67 Thermo

The energy-saving door impresses thanks to 67 mm thick sections with thermal break, achieving excellent thermal insulation, as well as with RC 2 security equipment as standard. ■ **NEW**.

LPU 42

The double-skinned LPU 42 door offers very good insulation with its 42 mm thick sections and is available with optional RC 2 security equipment.

LTE 42

The single-skinned LTE 42 door is the inexpensive solution for detached garages that do not require additional thermal insulation.



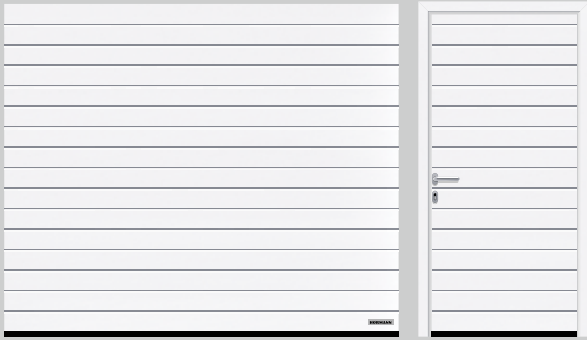

S-ribbed (LPU 42, LTE 42), Traffic white RAL 9016

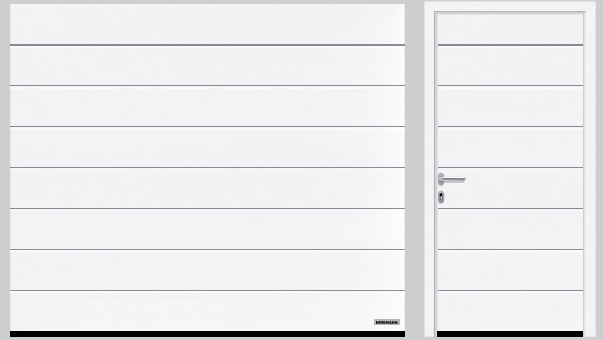

M-ribbed (LPU 67 Thermo, LPU 42, LTE 42), Traffic white RAL 9016

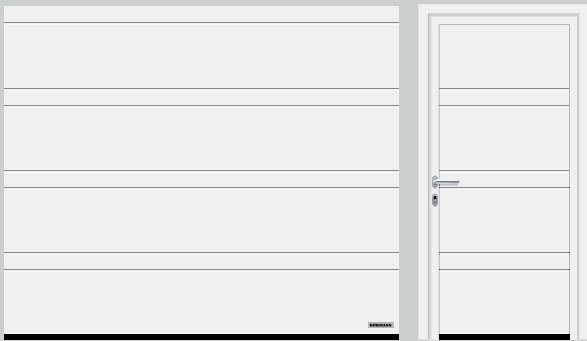

D-ribbed (LPU 42), Traffic white RAL 9016

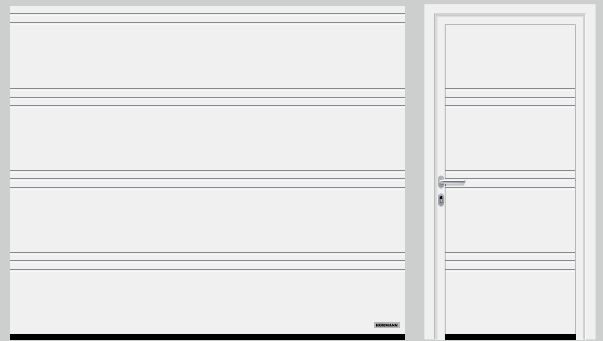

T-ribbed (LPU 42), Traffic white RAL 9016



L-ribbed (LPU 67 Thermo, LPU 42), Traffic white RAL 9016



Panelled (LPU 42, LTE 42), Traffic white RAL 9016

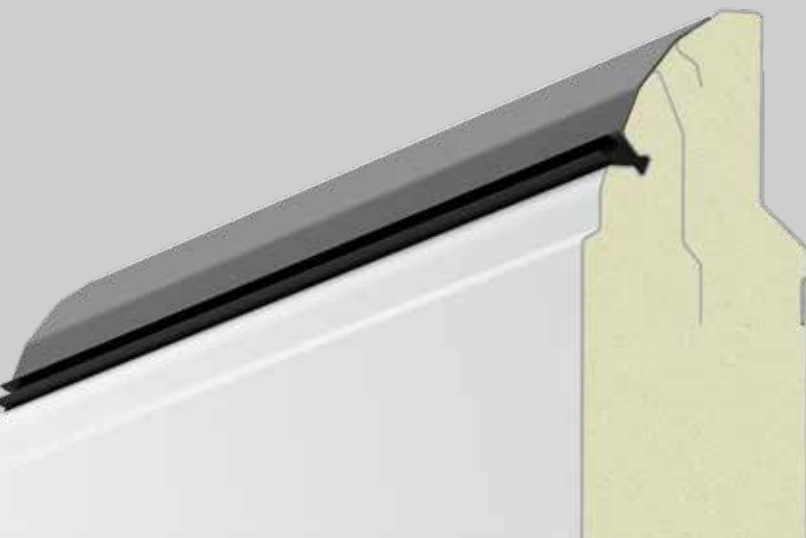



▲ S-ribbed in Woodgrain Anthracite grey RAL 7016; Hörmann aluminium entrance door ThermoSafe, style 650 Anthracite grey RAL 7016



▼ S-ribbed in Woodgrain Fir green RAL 6009 with optional stainless steel house number



▲ S-ribbed in Woodgrain Traffic white RAL 9016 with matching side door





▲ M-ribbed in Silkgrain Anthracite grey RAL 7016 with optional stainless steel house number; Hörmann aluminium entrance door ThermoSafe, style 861 Anthracite grey RAL 7016

M-RIBBED



► M-ribbed in Silkgrain Traffic white RAL 9016 with optional LED light strip on lintel, optional light key switch posts SLS and optional stainless steel house number





◀ M-ribbed in Decograin Titan Metallic CH 703 as industrial sectional door SPU F42 Plus for garages up to 7000 mm wide (for further information, see pages 52 – 53)

▼ M-ribbed in Woodgrain Anthracite grey RAL 7016, with practical wicket door to conveniently retrieve bicycles from the garage (for further information, see pages 60 – 61)







▲ L-ribbed in Decograin Titan Metallic CH 703

L-RIBBED



▲ L-ribbed in Duragrain Concrete

▶ L-ribbed design style 461 with glazing elements in Silkgrain CH 703; Hörmann aluminium entrance door ThermoSafe style 173





▼ L-ribbed in Planar CH 9007 Matt deluxe Grey aluminium



► T-ribbed in Silkgrain Anthracite grey
RAL 7016 style 501 with continuous inlays in
stainless steel look

▼ D-ribbed in Silkgrain Anthracite grey
RAL 7016; Hörmann aluminium entrance door
ThermoCarbon, style 304 Anthracite grey
RAL 7016

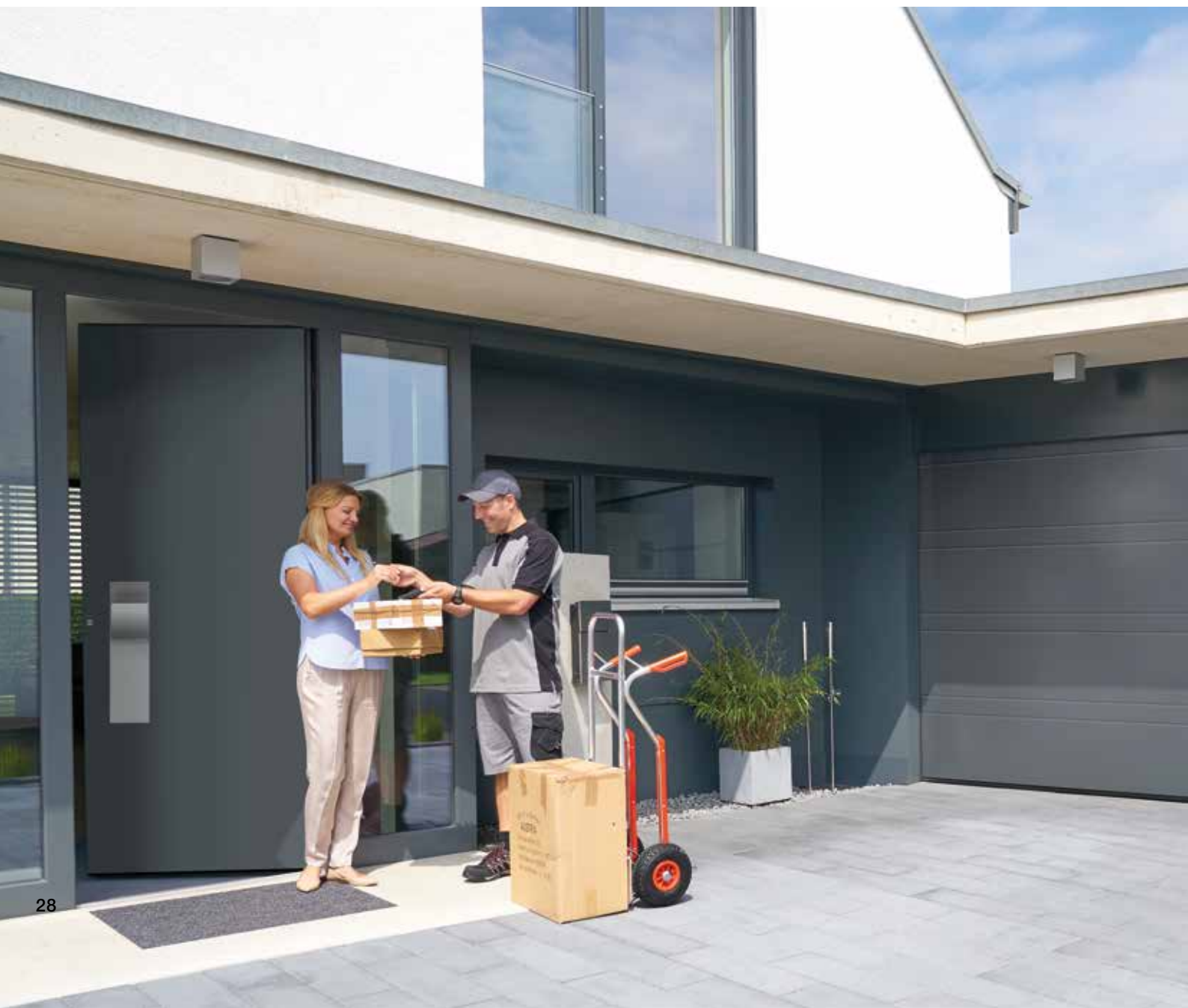



▲ T-ribbed in Silkgrain Anthracite grey RAL 7016 style 500 with divided inlays in timber look

PANELLED



▲ Panelled in Woodgrain Traffic white RAL 9016;
Hörmann aluminium entrance door ThermoSafe
style 449 in Traffic white RAL 9016

► Panelled in Decograin Golden Oak





◀ Panelled in Woodgrain Terra
brown RAL 8028



INDIVIDUAL DESIGN STYLES

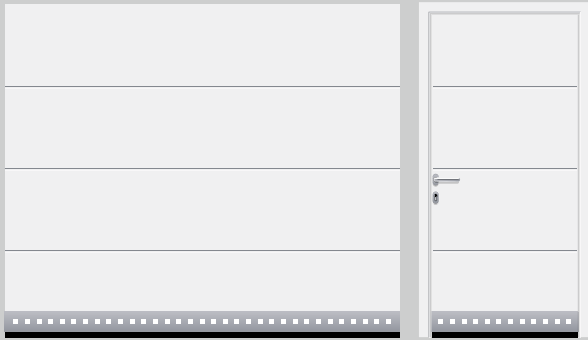

L-ribbed (LPU 67 Thermo, LPU 42), Traffic white RAL 9016, design element style 450



L-ribbed (LPU 67 Thermo, LPU 42), Traffic white RAL 9016, design element style 457



T-ribbed (LPU 42), Traffic white RAL 9016, inlay element style 501 and design element style 454 Anthracite grey RAL 7016

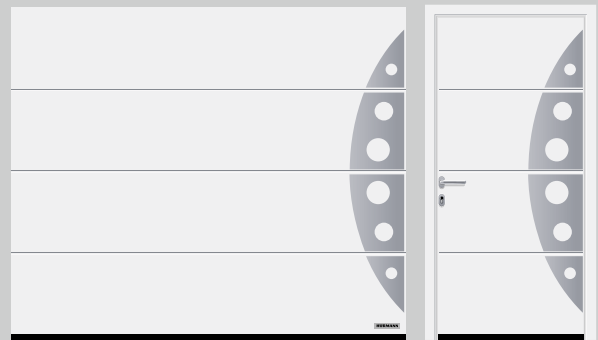

L-ribbed (LPU 67 Thermo, LPU 42), Traffic white RAL 9016, design element style 458

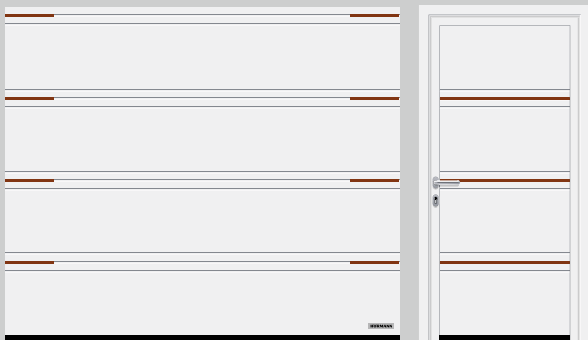

T-ribbed (LPU 42), Traffic white RAL 9016, inlay element style 500 with divided inlays in timber look

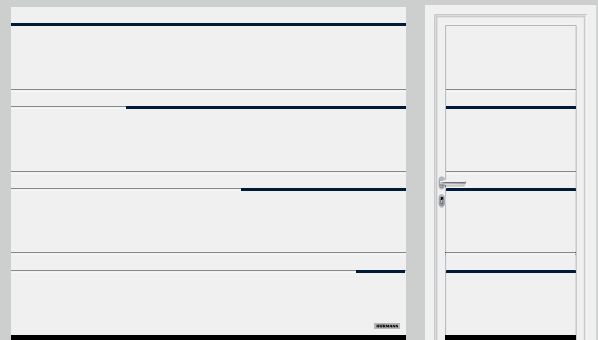

D-ribbed (LPU 42), Traffic white RAL 9016, inlay element style 502 in steel blue RAL 5011

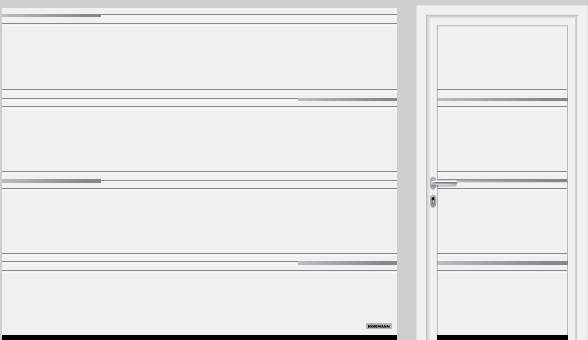

T-ribbed (LPU 42), Traffic white RAL 9016, inlay element style 503 in stainless steel look

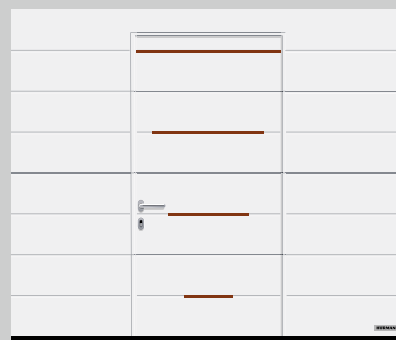

M-ribbed (LPU 42), Traffic white RAL 9016, inlay element style 504 in timber look, in the wicket door

Individual design styles

You can individually position and combine the design elements on your door, as shown in the door views. Design styles are available in brushed stainless steel as standard, or painted in all RAL colours on request. You can design your own door style. Doors with wicket door are also available with design elements. Your Hörmann partner would be pleased to advise you.

* only LPU 42

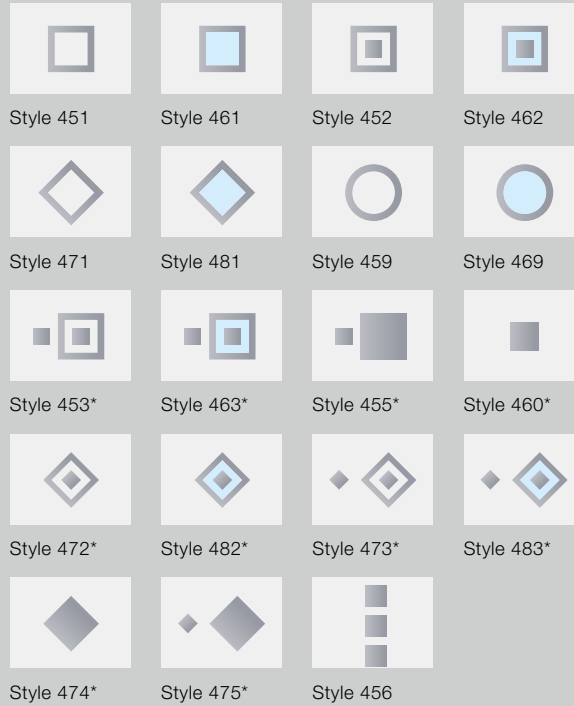

Design element in brushed stainless steel with optional real glass* for design styles 461 and 481

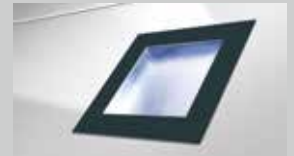

Design element painted in Anthracite grey RAL 7016 with synthetic glazing for design styles 461, 462, 463, 469, 481, 482 and 483

Special accent with inlays

M-ribbed, D-ribbed and T-ribbed doors are available in various inlay versions: e.g. continuous inlays run along the entire door width on style 501, while divided inlays, each 435 mm wide, are positioned on the left and right edges of door style 500.



T-ribbed with inlays in stainless steel look



T-ribbed with inlays in timber look



T-ribbed with inlays in RAL to choose (Fig. shows inlay in RAL 6018)

Design elements “numbers and words”

Design your garage sectional door LPU 42 with ribbing, house number, street name or text in the Modern or Classic fonts. Design elements are available in brushed stainless steel as standard, or painted in all RAL colours on request.



House number in positive characters, Modern font

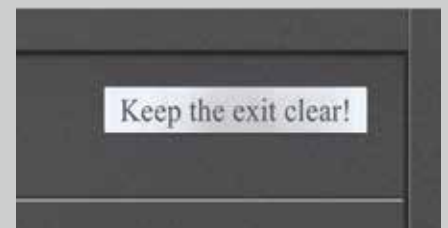

Text in negative characters, Classic font

Colour and decor variety

No matter the architectural style, with Hörmann, you are guaranteed to find a sectional garage door to fit your personal style and home. For steel sectional doors, you can choose between the robust Woodgrain surface finish or the silky-smooth Silkgrain surface finish in the standard colour Traffic white or in 15 inexpensive preferred colours. The Matt deluxe colours of the new Planar surface finish and the Sandgrain surface finish impress with timeless elegance. The 6 Decograin decors and the Duragrain surface finish with 24 decors gives you authentic and natural door views. The door surfaces are optimally protected against rust allowing you to enjoy your new door for a long time. Rain runs off without leaving any streaky marks thanks to the use of hot-galvanized material and a high-quality polyester-primer coating on both sides.





It's your choice

The Woodgrain and Silkgrain surface finishes are available as standard in Traffic white as well as in 15 inexpensive preferred colours and in around 200 colours from the RAL colour chart*, as well as in many NCS and DB colours.

1 Woodgrain

On this inexpensive, robust surface with an authentic sawn timber look, minor scratches can be easily repaired.

2 Silkgrain

Thanks to its elegant door appearance, the silky smooth Silkgrain surface finish is the first choice for modern architecture. A 50% thicker exterior sheet on the sections also ensures higher stability and even smoother running.

Please note:

Sectional garage doors are generally supplied in Grey white, RAL 9002, on the inside of the door.

Dark colours should not be used for double-skinned steel doors that are exposed to the sun, as possible section deflection may damage the door.

All colours based on RAL.

The colours and surfaces shown are subject to the limitations of the printing process and cannot be regarded as binding. Please consult with your local Hörmann specialised dealer.

* RAL Classic colours, with the exception of pearl-effect and fluorescent colours

Standard colour

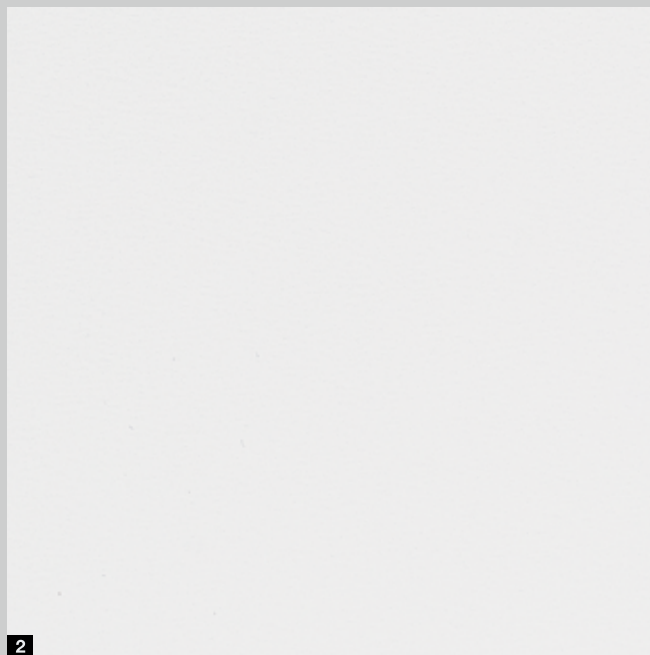

1 Woodgrain, RAL 9016 Traffic white

2 Silkgrain, RAL 9016 Traffic white

15 preferred colours

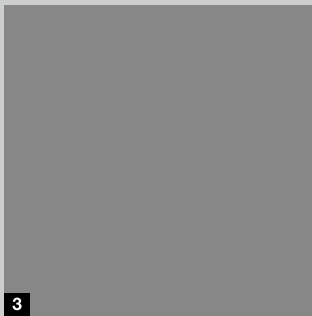

3

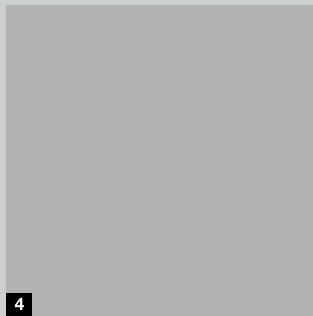

4

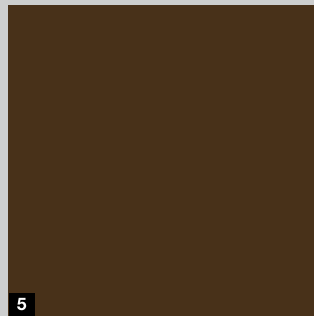

5

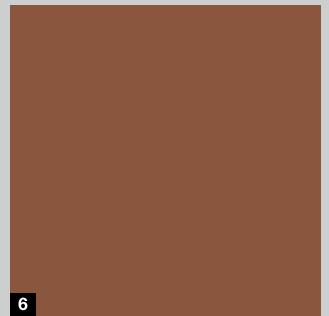

6

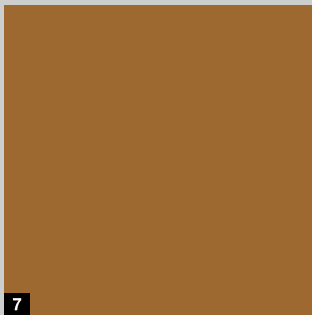

7

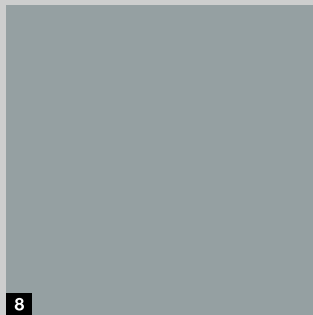

8

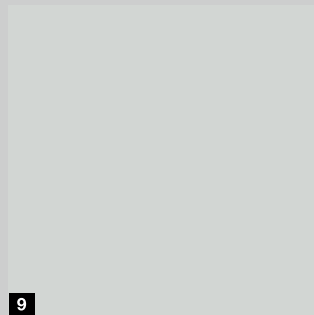

9

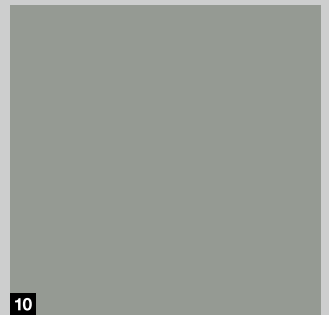

10

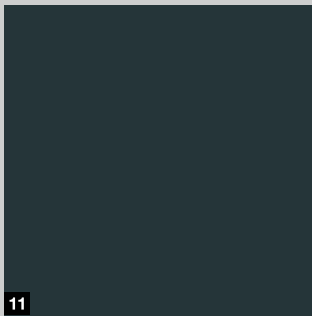

11

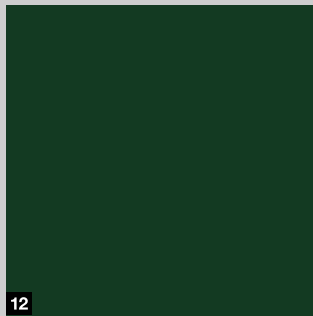

12

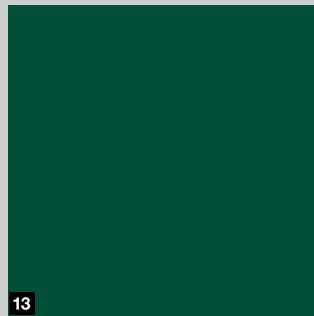

13

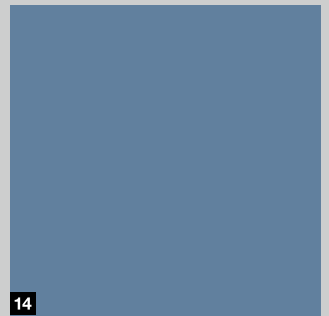

14

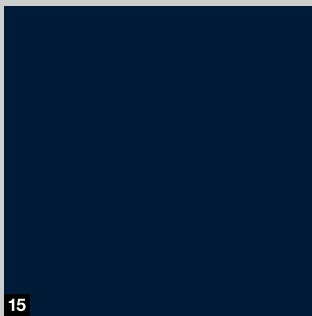

15

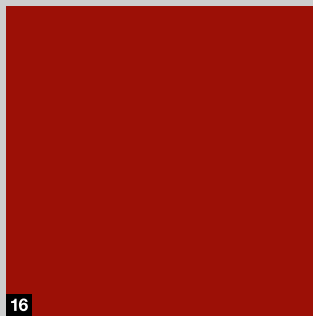

16

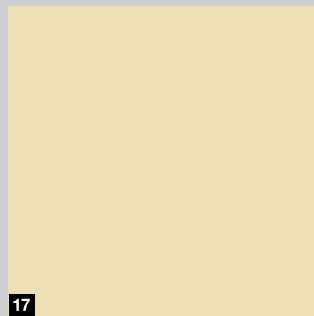

17

3 RAL 9007 Grey aluminium

7 RAL 8001 Ochre brown

11 RAL 7016 Anthracite grey

15 RAL 5011 Steel blue

4 RAL 9006 White aluminium

8 RAL 7040 Window grey

12 RAL 6009 Fir green

16 RAL 3003 Ruby red

5 RAL 8028 Terra brown

9 RAL 7035 Light grey

13 RAL 6005 Moss green

17 RAL 1015 Light ivory

6 RAL 8003 Clay brown

10 RAL 7030 Stone grey

14 RAL 5014 Pigeon blue

Timeless and elegant

The new Planar surface finish in 6 exclusive Matt deluxe Hörmann colours meets all expectations of a modern and timeless door design. It impresses by combining a smooth surface finish with fine elegance and matt trendy colours.

The finely textured Sandgrain surface finish is an ideal choice for price-conscious building owners and is particularly suited for modern homes. You can choose between the standard colour Traffic white and 3 inexpensive preferred colours.

6 Planar colours Matt deluxe



4 Sandgrain colours

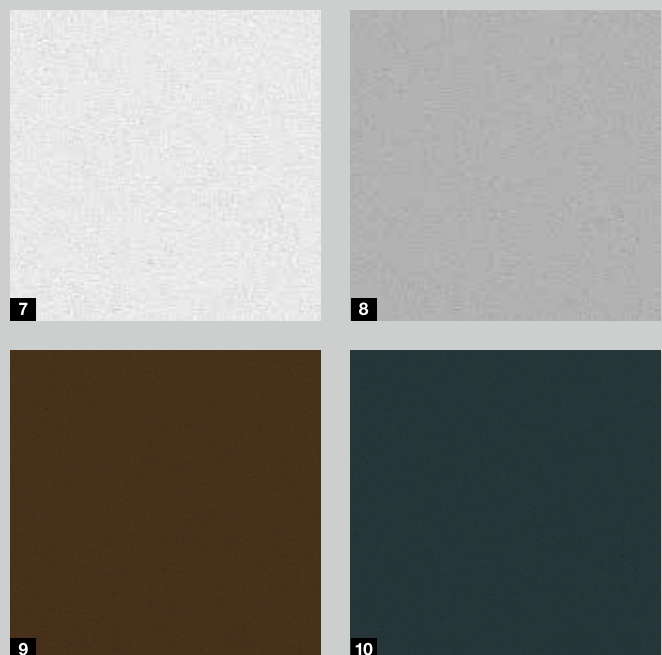

Planar surface finish

Standard colour

1 CH 9016 Matt deluxe Traffic white

Preferred colours

2 CH 9006 Matt deluxe White aluminium

3 CH 9007 Matt deluxe Grey aluminium

4 CH 7016 Matt deluxe Anthracite grey

5 CH 8028 Matt deluxe Terra brown

6 CH 703 Matt deluxe Anthracite metallic

Sandgrain surface finish

Standard colour

7 RAL 9016 Traffic white

Preferred colours

8 RAL 9006 White aluminium

9 RAL 8028 Terra brown

10 RAL 7016 Anthracite grey



6 Decograin decors

Detailed and natural look

Decograin is available in five natural-looking timber designs and with an anthracite metallic effect. An embossed wood grain gives it an authentic timber character. The door remains beautiful for a long time thanks to the special surface protection of the UV-resistant plastic film coating on the outside of the steel sections.

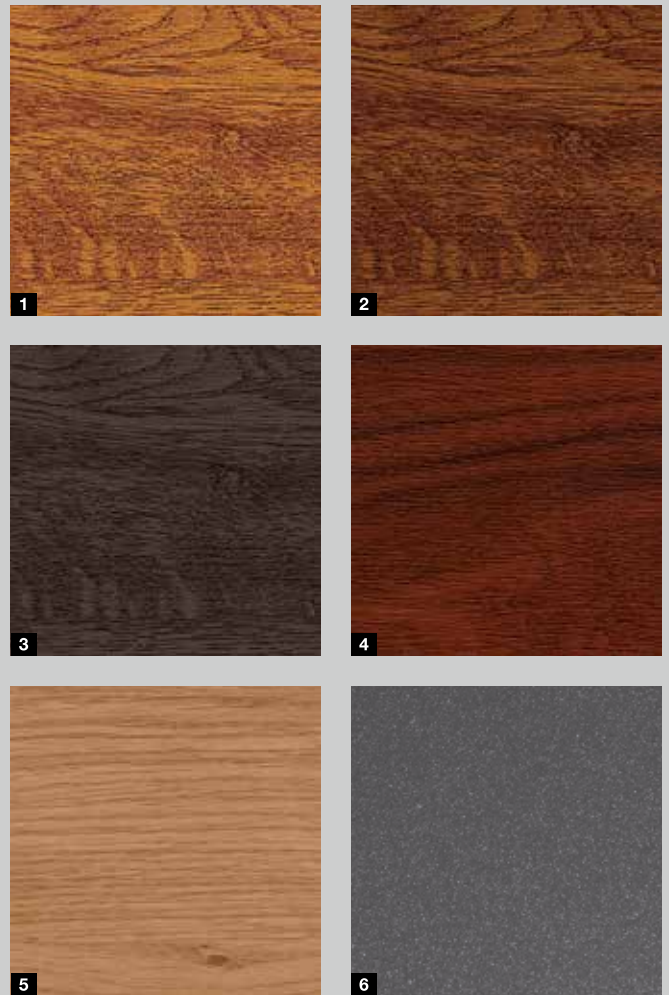

Decograin surface finish

- 1 Golden Oak: medium brown, golden yellow oak design
- 2 Dark Oak: walnut-coloured oak decor
- 3 Night Oak: dark, intense oak design**
- 4 Rosewood: mahogany-coloured timber design**
- 5 Winchester Oak: natural-coloured knotty oak design**
- 6 Titan Metallic CH 703: Anthracite with a metallic effect

* The complete warranty conditions can be found at: www.hormann.co.uk

** Not for LPU 67 Thermo

Only from Hörmann

with high-strength protective coating

Versatile and permanently beautiful

For the Duragrain surface finish with its detailed, natural and colourfast door surface, you can choose from 24 decors. In this collection you are guaranteed to find a decor that harmonises perfectly with the architecture of your home.

The innovative digital printing process in combination with the final high-strength protective coating is the basis for a permanently beautiful door view.

24 Duragrain decors



1



2

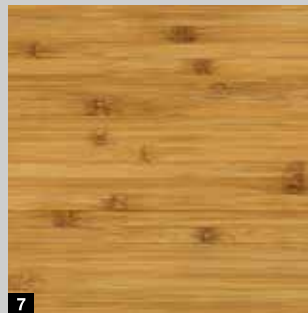

7

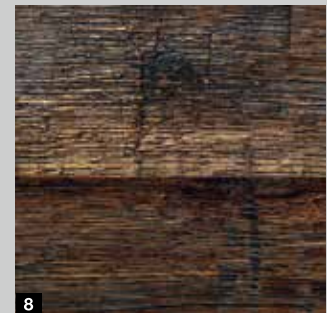

8



13

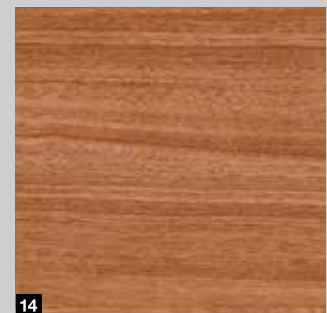

14



19



20

1 Concrete

7 Bamboo

13 Noce Sorrento Balsamico

19 Terra Walnut

2 Beige

8 Burned Oak

14 Noce Sorrento, plain

20 Colonial Walnut



Duragrain surface finish



For further information, see the "Duragrain surface finish" brochure.

* The complete warranty conditions can be found at: www.hormann.co.uk

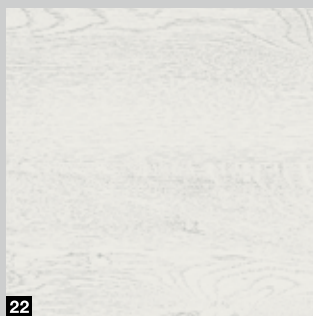
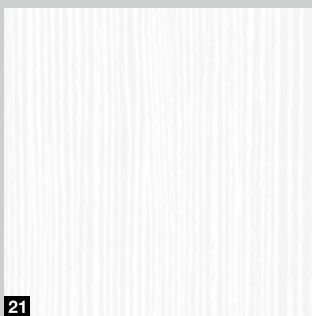
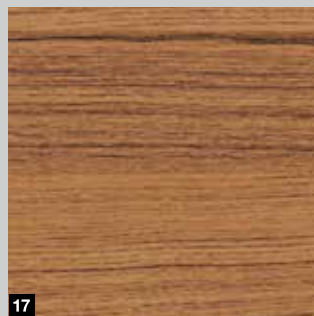
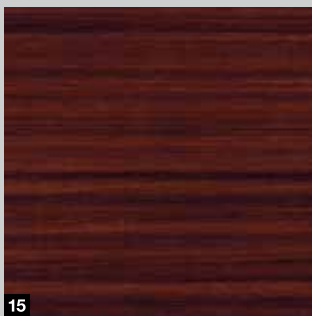
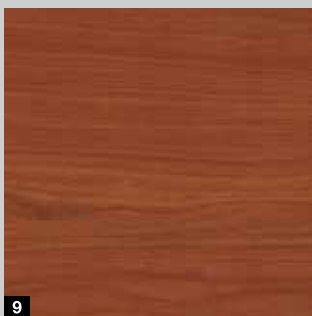

- 3 Mocca
- 9 Cherry
- 15 Sapele
- 21 White Brushed

- 4 Grigio
- 10 Nature Oak
- 16 Sheffield
- 22 White Oak

- 5 Grigio Scuro
- 11 Pine
- 17 Teak
- 23 White Oiled Oak

- 6 Rusty Steel
- 12 Rusty Oak
- 18 Weathered Look
- 24 Whitewashed Oak

Please note:

Duragrain doors are generally supplied in Grey white, RAL 9002, on the inside of the door. When the door is opened, a thin Grey white stripe can be seen between the sections on the outside.

Side frames and fascia panels are delivered in Woodgrain, Traffic white RAL 9016 as standard. Optionally, you can obtain lintel and frame fascias in a colour matching the decor or in RAL to choose.

OVERVIEW OF STEEL SECTIONAL DOORS

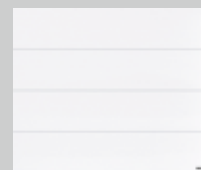
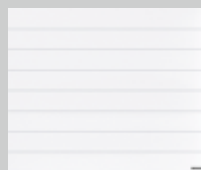

S-ribbed

M-ribbed

L-ribbed

LPU 67 Thermo

Double-skinned steel sectional doors

	S-ribbed	M-ribbed	L-ribbed
Silkgrain		Traffic white RAL 9016 15 preferred colours RAL to choose	Traffic white RAL 9016 15 preferred colours RAL to choose
Decograin		3 decors: Golden Oak, Dark Oak, Titan Metallic CH 703	3 decors: Golden Oak, Dark Oak, Titan Metallic CH 703
Max. width		5000 mm	5000 mm
Max. height		3000 mm	3000 mm

LPU 42

Double-skinned steel sectional doors

	S-ribbed	M-ribbed	L-ribbed
Woodgrain	Traffic white RAL 9016 15 preferred colours RAL to choose	Traffic white RAL 9016 15 preferred colours RAL to choose	Traffic white RAL 9016 15 preferred colours RAL to choose
Sandgrain		Traffic white RAL 9016 3 preferred colours	Traffic white RAL 9016 3 preferred colours
Silkgrain		Traffic white RAL 9016 15 preferred colours RAL to choose	Traffic white RAL 9016 15 preferred colours RAL to choose
Planar ■ NEW			6 Hörmann colours Matt deluxe
Decograin		6 decors: Golden Oak, Dark Oak, Night Oak, Rosewood, Winchester Oak, Titan Metallic CH 703	6 decors: Golden Oak, Dark Oak, Night Oak, Rosewood, Winchester Oak, Titan Metallic CH 703
Duragrain			24 decors
Max. width	6000 mm	6000 (7000*) mm	6000 (7000*) mm
Max. height	3000 mm	3000 (5000*) mm	3000 (5000*) mm

LTE 42

Single-skinned steel sectional doors

	S-ribbed	M-ribbed	L-ribbed
Woodgrain	Traffic white RAL 9016	Traffic white RAL 9016	
Max. width	5000 mm	3000 mm	
Max. height	3000 mm	3000 mm	

* As sectional door SPU F42 Plus (for further information, see pages 52 – 53)

Please note:

Detailed size ranges can be found on page 82.



D-ribbed

T-ribbed

Panelled

Traffic white RAL 9016
15 preferred colours
RAL to choose

Traffic white RAL 9016
15 preferred colours
RAL to choose

Traffic white RAL 9016
15 preferred colours
RAL to choose

5 decors: Golden Oak, Dark Oak,
Night Oak, Rosewood, Winchester
Oak

6000 mm
3000 mm

6000 mm
3000 mm

5500 mm
3000 mm

Traffic white RAL 9016

3000 mm
3000 mm

Configurator

With the door configurator, you can conveniently test many design and product variations on your own PC or tablet in advance. You can put your dream door together in just a few clicks by selecting the door type, surface finish, colour and size.



The Hörmann configurator can be found on our website.

LTH 42

Solid timber doors with a smooth or brushed surface are excellently suited for timber houses or buildings with many timber elements, such as timber framing or facade elements. Choose from 9 door styles or design your own timber door: With the help of a computer milling machine, we will manufacture your individual door.

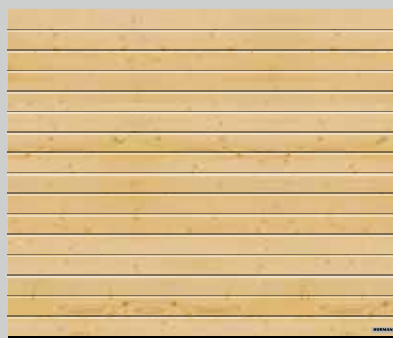

S-ribbed, Nordic Pine

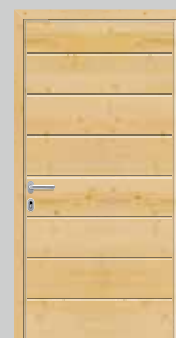
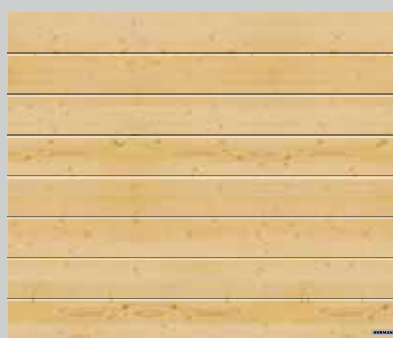

M-ribbed, Nordic Pine

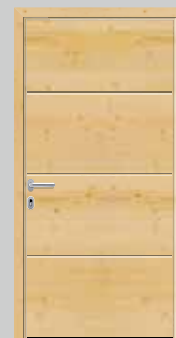

L-ribbed, Nordic Pine

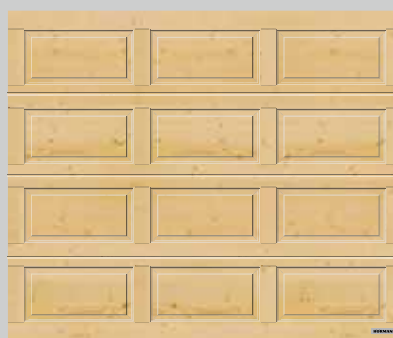

Panelled, Nordic Pine



Style 401, Nordic Pine



Style 402, Nordic Pine

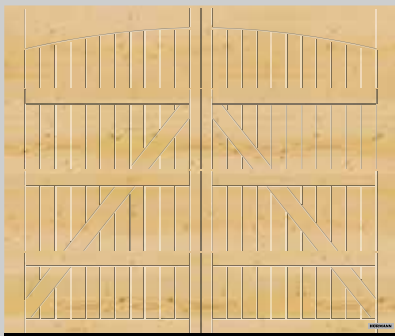

Style 405, Nordic Pine

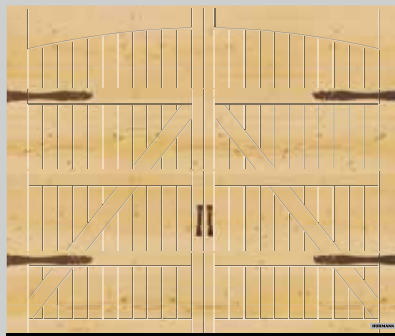

Style 405, with optional hinged door fittings "Exclusive", Nordic Pine

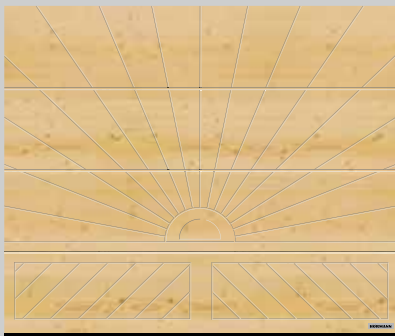

Style 403, Nordic Pine

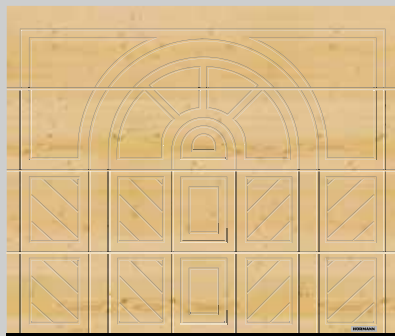

Style 404, Nordic Pine

Setting accents

In styles 403 and 404, natural stone is used as an attractive design feature. Choose from the 3 natural stones Tropical green, Multicolour red and Balmoral rosso (variations in colour and texture are a natural characteristic).



Tropical green



Multicolour red



Balmoral rosso

Types of timber



1



2

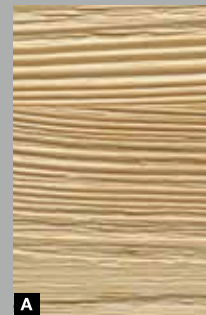

A



B

8 types of wood preservative

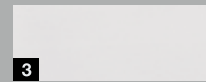

3



4



5



6



7



8



9



10

- 1 Nordic Pine
- 2 Hemlock
- A Nordic Pine with brushed surface finish
- B Hemlock with brushed surface finish
- 3 Limestone white, painted or opaque
- 4 Pine
- 5 Teak
- 6 Rosewood
- 7 Ebony
- 8 Agate grey
- 9 Fir green
- 10 Nordic red

SOLID TIMBER SECTIONAL DOORS

► Door style 405, painted white on site with hinged door fittings and decorative handles

▼ M-ribbed with solid timber panels in Hemlock



◀ Door style 402 in Nordic Pine with a matching side door



Individual designs

Design your timber door to, for example, display your initials, house number or your favourite style. Just provide us with an appropriate drawing and we will create a personal garage door for you. It will be an enviable original.

Elegant transparency

The exclusive aluminium frame door ALR F42 Vitraplan impresses with an engaging mix of mirroring and transparency. The ART 42 / ART 42 Thermo with 13 infill variations provides for more light or improved ventilation in the garage.



ALR F42 Vitraplan

The door is especially elegant thanks to offset, flush-fitting glazing. The frame profile is concealed, so nothing detracts from the overall appearance.



ART 42 / ART 42 Thermo

The Hörmann aluminium frame door with standard profile **1** or profile with thermal break **2** impresses with more light in the garage or better ventilation in the parking boxes of collective garages.



1

2

ART 42

ART 42 Thermo

Infill variations



Polycarbonate double pane, clear
Synthetic double pane, clear



Synthetic double pane, white tinted (opal / clear)

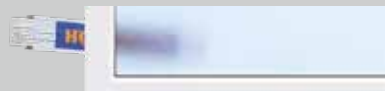

Synthetic double pane, crystal texture

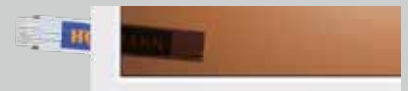

Synthetic double pane, brown tinted



Multiple-moulded pane

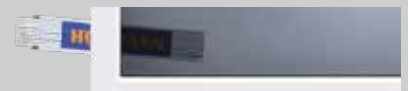

Synthetic double pane, grey tinted



PU sandwich infill, smooth ■ **NEW**



PU sandwich infill, Stucco ■ **NEW**



Perforated stainless steel sheet



Stainless steel expanded mesh



Crimped mesh



Welded grille

OVERVIEW OF SOLID TIMBER SECTIONAL DOORS



S-ribbed



M-ribbed

Solid timber sectional doors LTH

Nordic Pine	8 types of wood preservative Brushed surface finish	8 types of wood preservative Brushed surface finish
Hemlock	8 types of wood preservative Brushed surface finish	8 types of wood preservative Brushed surface finish
Max. width	5000 mm	5000 mm
Max. height	3000 mm	3000 mm



L-ribbed



Panelled

Solid timber sectional doors LTH

Nordic Pine	8 types of wood preservative Brushed surface finish	8 types of wood preservative
Hemlock	8 types of wood preservative Brushed surface finish	8 types of wood preservative
Max. width	5000 mm	5000 mm
Max. height	3000 mm	3000 mm

Please note:

Detailed size ranges can be found on page 82.

OVERVIEW OF ALUMINIUM FRAME DOORS



ART 42



ART 42 Thermo

Aluminium frame door

Frame	Traffic white RAL 9016 15 preferred colours 6 Hörmann colours Matt deluxe RAL to choose	Traffic white RAL 9016 15 preferred colours 6 Hörmann colours Matt deluxe RAL to choose
Infills	13 variants	13 variants
Max. width	5500 mm	5500 mm
Max. height	3000 mm	3000 mm

Please note:

Detailed size ranges can be found on page 82.

Configurator

With the door configurator, you can conveniently test many design and product variations on your own PC or tablet in advance. You can put your dream door together in just a few clicks by selecting the door type, surface finish, colour and size.



The Hörmann configurator can be found on our website.

For special door and facade designs

With the industrial sectional door ALR F42, your garage door is seamlessly integrated into the overall design of your home. The industrial sectional door SPU F42 Plus is the ideal solution for especially wide garages and for fitting situations where an operator cannot be fitted above the door.



ALR F42 for on-site cladding flush with the facade

Design your sectional door according to your wishes with timber, metal, ceramics, plastic and many other materials.

The door basis for facade cladding is a Hörmann industrial sectional door ALR F42 with an aluminium frame construction and PU sandwich infill. For further information, see the planning aid at www.hoermann.de or seek the expert advice of your Hörmann specialised dealer.



SPU F42 Plus for door openings up to 7000 mm wide and special fitting situations

For M- and L-ribbed garage doors over 6000 mm wide, the **SPU F42 Plus with the powerful operator SupraMatic 3 HT 1** is the first choice. The rail-guided operator features the same functions, such as soft start and soft stop, adjustable ventilation slot and automatic door locking. If it is not possible to install the operator in the garage in the centre with a guide rail, we recommend the **SPU F42 Plus with the shaft operator WA 300 S4 2** for side fitting. This operator does not require additional lintel. Additionally, it features standard power limit, soft start and soft stop, very high security and quiet door travel.



1 Operator SupraMatic 3 HT



2 Shaft operator WA 300 S4



For more detailed information, please see the "Industrial sectional doors" brochure

Operating comfort with the highest security



Safety while operating the garage door is top priority for Hörmann. And Hörmann sets the standards for this with its innovative solutions. This has been proven time and time again through numerous Hörmann patents. Hörmann sectional doors are tested and certified in accordance with the high safety requirements of European standard 13241, not only on their own but also in combination with operators. It would be hard to find a safer sectional door. And this provides you and your family with safety during daily use.

It pays to compare!





1

Hörmann patent

1 Tension spring assembly with multi-spring system

Double tension springs and cables on each side safeguard the door leaf against falling. Thanks to the patented spring-in-spring system, broken springs are prevented from flying out and causing injuries. Sectional doors up to 4000 mm wide or 2625 mm high include the proven tension spring technology as standard*.



2

Hörmann patent

2 Torsion spring assembly with integrated spring safety device

Torsion springs on both sides feature a patented spring safety device. In the event of a spring breaking, they arrest the door travel immediately, thereby preventing the door leaf from falling. Larger sectional doors and doors with integrated wicket door or solid timber panels feature torsion spring technology.



3

Hörmann patent

3 Secure guidance of the door in safety tracks

Patented, adjustable rollers, sturdy roller holders and safety tracks ensure that there is no danger of the door "derailing". The door leaf is safely parked under the ceiling.



4

4 Finger trap protection on the inside, outside and on the hinges

The unique shape of the door sections eliminates trap points, both between the sections and on the hinges.



5

5 Trap guard on the side frame

With Hörmann, the frames are completely closed from top to bottom. There are no gaps between the door leaf and frame in which fingers could get trapped!

* Please refer to the size range on page 82 for detailed information.

For a beautiful interior door view

The premium version of the LPU 42, LPU 67 Thermo, ART 42 and ART 42 Thermo doors impresses with its harmonious interior door view. The fittings, frames, tracks and tracks are designed to match the inside of the sections. Tandem track rollers also ensure very quiet and gentle door travel.



Standard version (Fig. LPU 67 Thermo)
Galvanized fittings, frame, tracks and connection rails



Premium version (Fig. LPU 67 Thermo)
Fittings, frames, tracks and connection rails in Grey white RAL 9002* and tandem track rollers

* Galvanized spring assembly incl. holder, spring safety device, cable drum, operator boom

For more security

Apart from doors and windows, burglars often try to break in through the garage door to enter the house via a connecting door or to steal items from the garage. The sectional garage door LPU 67 Thermo and optionally the LPU 42 come with certified RC 2 security equipment as standard.



This carefully tested burglar protection is also recommended by police information centres. Further information can be found at www.k-einbruch.de

Aesthetic, understated, secure

Manual release

If your garage does not have a second entrance, you can optionally open your automatic garage door LPU 42, LTE 42 and LTH 42 from the outside with a beautifully designed handle or an understated emergency release lock.

Door handles

Hörmann door handles are set apart by a contemporary, modern shape. Here, the selection of material is not just a question of personal taste. For example, stainless steel handles are particularly robust and have a tough surface finish. The lock can be integrated in the master key system. Manually operated doors with a handle are locked with a latch lock **5**, providing break-in resistance. In this lock, a sturdy, automatic latching spring disc engages around a massive bolt on the side frame.

Emergency release

If you do not want a handle on your automatic sectional door, we recommend using an emergency release lock **6** on garages without a second entrance. An inconspicuous round cylinder (cannot be integrated in the master key system) releases your garage door and you can easily open it in the case of an emergency. For automatic sectional doors with a handle, you can use a door handle to operate the emergency release. The door is then unlocked via a Bowden cable on the inside.



1



2



3



4



5



6

- 1 Black plastic
- 2 White cast aluminium, RAL 9016
- 3 Brushed stainless steel
- 4 Brown cast aluminium, RAL 8028
- 5 Latch lock
- 6 Emergency release lock

For sectional doors LPU 42, LTE 42 and LTH 42

Please note:

More light, less energy consumption

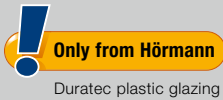

Depending on the door type, you can select from various types of glazings with clear or textured panes. Clear synthetic glazing from Hörmann comes as standard with DURATEC glazing. It offers:

- Maximum scratch resistance
- A permanently clear view
- Improved thermal insulation

Your Hörmann partner would be pleased to advise you about the numerous glazing options. The glazing frames are supplied in a colour to match the decor with the Decograin surface finish.

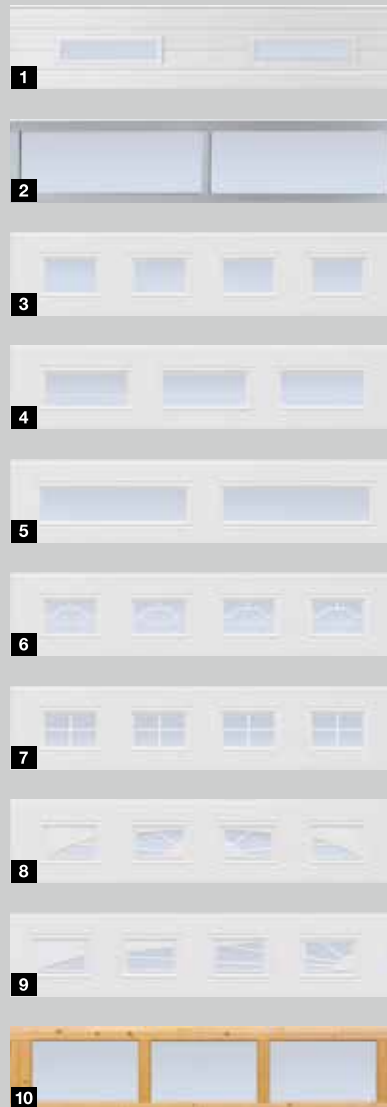

Synthetic double pane, clear



Synthetic double pane, crystal texture

- | | | | |
|---|---|----|--------------------------------------|
| 1 | Glazing type D ¹⁾ | 2 | Aluminium light strips ²⁾ |
| 3 | Classic glazing S0 ¹⁾ | 4 | Classic glazing M0 ¹⁾ |
| 5 | Classic glazing L0 ¹⁾ | 6 | Classic glazing S1 |
| 7 | Classic glazing S2 | 8 | Sunrise glazing S10 ³⁾ |
| 9 | Sunrise glazing S60 ⁴⁾ (Fig. left door half) | 10 | V-panelled glazing V0 |

Glazings (1 to 8, 10) correspond to a door width of 2500 mm

- ¹⁾ Individual arrangement of glazings is possible
- ²⁾ Rails are possible
- ³⁾ Door width 2130 – 2750 mm
- ⁴⁾ Door width 4751 – 5500 mm

Please note:

Glazing is also possible in the two bottom door sections after technical inspection.

An easy passage into your garage

A door in the garage door lets you easily access whatever you have in your garage, such as gardening tools, bikes or wheelbarrows. The clear opening width of 830 mm or 1140 mm offers a convenient passage, even for wide equipment or bicycles, motorbikes and scooters. Only Hörmann offers wicket doors with a stainless steel threshold that is merely 10 mm high in the centre and 5 mm high at the sides. This reduces the risk of tripping and makes it easier to wheel things through. The top garage door section comes with a continuous lintel seal, also in the wicket door area. ■ **NEW:** Doors with wicket door are now also available with RC 2 security equipment. For further information, see page 57.

Please note:

Wicket doors with trip-free threshold are only available for sectional door LPU 42 up to a door width of 5 m.

The aluminium door frame is anodised as standard in a natural finish and is also available in all RAL colours. On request, wicket doors with Planar, Decograin and Duragrain surface finish can be supplied with the frame painted to match the colour of the decor. The frame is available in all RAL colours, also different from the door colour.

In some cases, adjacent panelled doors with the same width, with and without a wicket door, may not have a uniform panel spacing.

Manually operated garage doors with wicket door do not have an exterior door handle. They are locked from the inside.





1 Overhead door closers

As standard, wicket doors are supplied with slide rail door closers incl. integrated opening limiter and hold-open device (top Fig.). An integrated door closer including hold-open device (bottom Fig.) is optionally available for optimum protection and the best appearance.

2 Optional multiple-point locking

The wicket door is locked over the entire door height with one bolt and hook bolt per section. The advantage: better stability and improved break-in resistance.

3 Robust door catch

This prevents the door leaf from dropping and warping.

4 Concealed hinges

For a uniform door appearance, the wicket doors are equipped with concealed hinges as standard.

Optional photocell

The leading photocell VL 2 stops the door without contact. This further increases the safety of your garage door with wicket door and trip-free threshold.

Garage side doors NT 60

The doors are supplied ready-to-fit with profile cylinder mortice lock, round lever handle set with oval rose escutcheons and with 3-way adjustable hinges. The leaf frame is available in a narrow (profile type 1) or a wide (profile type 2) version. The frame is made of weather-proof aluminium extrusions (depth 60 mm) with all-round seals. Double-leaf side doors are also available with asymmetrical division, i.e. with uneven door leaf widths.

Garage side door NT 60	Single-leaf	Double-leaf
Aluminium block frame	●	●
Aluminium corner frame	●	–
Narrow leaf frame (profile type 1)	●	–
Wide leaf frame (profile type 2)	●	●
Air permeability	Class 2*	–
Resistance to wind load	C3 / B3*	–
Thermal insulation U-value in W/(m ² ·K)	2,7	2,9

* Tested for door with wide leaf frame (profile type 2)

● = Equipment options



Single-leaf NT 60 with narrow leaf frame (profile type 1)

Single-leaf NT 60 with wide leaf frame (profile type 2)



Double-leaf NT 60 with wide leaf frame (profile type 2)

Insulated version NT 80

The garage side doors TopComfort NT80 impress with an aluminium profile system, frame and threshold rail with thermal break, as well as a depth of 80 mm.



Garage side doors TopComfort NT 80 with thermal break



1

1 Lever handle set

Choose between the standard lever handle or many optional lever handle or lever / knob handle sets (stainless steel lever handle set shown). Your Hörmann partner would be pleased to advise you.



2

2 Concealed hinges

For an elegant door view of single-leaf and double-leaf side doors in the version with aluminium block frame, concealed hinges are optionally available.



3

3 Fixed bolt

The fixed leaf on double-leaf side doors can be individually locked.

4 Matching appearance

Decograin side doors come with identical surface finish for the frame and door to create a matching appearance. The inside of the sections is Grey white, RAL 9002, as standard.



4

5 Break-in-resistant

You can also optionally equip side doors NT 60 with a wide leaf frame (profile type 2) in RC 2 security equipment with 3-point locking (latch, bolt, 2 locking hooks) and security rose escutcheon.



5



The approved burglar protection of our side doors with 3-point locking is also recommended by police information centres.



Multi-purpose door MZ Thermo

If you value good thermal insulation and also want to reduce the risk of condensation forming on the inside, an external door MZ Thermo with thermal break is the best choice for you.

It has an excellent thermal insulation value of 1.2 W/(m²·K). An RC 2 version is optionally available (KSI Thermo).



For further information, see the "Steel doors" brochure.

For easy access to the garage

With the double-leaf hinged garage door, you can either open both leaves or even just one leaf, in order to get your bike out of the garage, for example. Enjoy maximum comfort by equipping your hinged garage door with a ProMatic 4 or SupraMatic 4 operator. The thermally insulated 42 mm thick sections provide good insulation and are available in all surface finishes.





1 Customised leaf division

Design your hinged garage door entirely to suit your needs. The door leaves are available in both symmetrical and asymmetrical division. The symmetrical division, with door leaves of equal width, offer a harmonious door view. In the asymmetrical division, the traffic leaf comes in a width of 870 mm, which allows easy pedestrian passage into the garage. The width of the fixed leaf results from the total width of the door. You can also choose to position the traffic leaf on the left or right side of the door. Three sturdy hinges per door leaf (one hinge with safety device) also provide reliable door operation.



2 60 mm thick aluminium frame profiles

The frame profile seals reliably with a 3-sided double door seal and double lip seal in the threshold area. The door infill made of 42 mm thick sections is available in the S-ribbed, M-ribbed, L-ribbed, D-ribbed and T-ribbed styles and in all colours and decors. We supply the smooth aluminium frame profile in the colour of the sections, or for Decograin and Duragrain infills in a colour matching the decor.



3 Secure locking system

For a reliable locking of the door, the traffic leaf is equipped as standard with an aluminium lever handle set and a lock with profile cylinder. The fixed leaf is securely locked using a door bolt. In order to fix the leaves when open, the traffic leaf and the fixed leaf can be equipped with additional door stays on the floor. A door stay with braking and damping function fitted on the top edge of the leaf is particularly convenient. It stops the door from slamming and opening and can be locked in any position.



4 Convenient operator systems*

The operator-driven version is fitted with a hinged door fitting incl. cover for the ProMatic 4 and SupraMatic 4 operators. **The door also features concealed hinges, creating an elegant door view on the outside,** and a finger guard or trap guard **5** for excellent security inside.

* Only possible with symmetrical division

Outstanding performance characteristics



A well-insulated garage door is always recommended when the garage and the home are directly connected. The ThermoFrame frame connection further improves the already high insulation values of the double-skinned Hörmann sectional garage doors.

This reduces your energy costs.



Improved thermal insulation with ThermoFrame

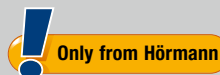

The plastic profile can be easily fitted together with the door frame, creating a thermal break between the frame and brickwork, thus improving thermal insulation by up to 15%*. In addition, extra lip seals on both sides and in the upper section of the door lower the loss of heating energy from the garage interior. The ThermoFrame frame connection is optionally available for all Hörmann sectional garage doors.

* For a double-skinned sectional garage door LPU 42 with the dimensions 5000 x 2250 mm

Thermal insulation

The thick insulated sandwich sections insulate just as well as a brick wall. This means that your garage is not wasting any energy and is saving you real money.



Acoustic insulation

The excellent acoustic insulation of the LPU sections reduces road traffic noise (approx. 80 dB(A)) to room volume level (approx. 55 dB(A)). This way, you can do what you want in your garage, whether you want to work in peace or throw a party.



Wind load

The LPU door sections are extremely sturdy so that your door can even withstand wind forces of up to 120 km/h, equivalent to hurricane force, without a problem. This means optimum protection for your garage and everything in it.



Sealing

Your garage is also well protected from heavy rain. Due to the all-around seals between the door leaf and frame as well as the seals between the sections, virtually no rain can penetrate a closed door.



Performance characteristics according to European standard 13241

Door type	Section	Thermal insulation		Acoustic insulation	Wind load ⁶⁾	Sealing	
		Fitted door without ThermoFrame	Fitted door with ThermoFrame			Air	Water
LPU 67 Thermo	U = 0.33 W/(m ² ·K)	U = 1.0 W/(m ² ·K) ¹⁾	U = 0.88 W/(m ² ·K) ¹⁾	R = approx. 25 dB	Class 3	Class 3 ⁵⁾	Class 3 ⁴⁾
LPU 42	U = 0.5 W/(m ² ·K)	U = 1.4 W/(m ² ·K) ¹⁾	U = 1.2 W/(m ² ·K) ¹⁾	R = approx. 25 dB	Class 3	Class 3 ⁵⁾	Class 3 ⁴⁾
LTE 42		U = 6.5 W/(m ² ·K) ¹⁾		R = approx. 20 dB	Class 2	Class 0 ³⁾	Class 0 ³⁾
ART 42		U = 4.0 W/(m ² ·K) ¹⁾	U = 3.8 W/(m ² ·K) ¹⁾	R = approx. 20 dB	Class 2	Class 3	Class 3
ART 42 Thermo		U = 3.4 W/(m ² ·K) ²⁾	U = 3.2 W/(m ² ·K) ²⁾	R = approx. 20 dB	Class 2	Class 3	Class 3
LTH			U = 3.0 W/(m ² ·K) ¹⁾		Class 3	Class 0 ³⁾	Class 0 ³⁾
DFT 42		U = 2.9 W/(m ² ·K) ⁷⁾			Class 3	Class 2	Class 1

¹⁾ The U-values apply to fitted doors without glazing with the dimensions 5000 × 2250 mm

²⁾ The U-values apply to fitted doors with synthetic double panes (S2), 26 mm, with the dimensions 5000 × 2250 mm

³⁾ Doors with ventilation slots, classes 2 – 3 on request

⁴⁾ Up to 70 Pa water pressure

⁵⁾ Available for panelling and L-ribbing (LPU 42 doors with S-, M-, D- or T-ribbing as well as with wicket door: class 2)

⁶⁾ Higher wind load classes on request

⁷⁾ The U-values apply to fitted doors without glazing with the dimensions 2200 × 2180 mm

Fast door opening, more convenience, smart functions

Hörmann garage door operators are perfectly matched to your Hörmann sectional door. The automatic safety cut-out stops the door securely and reliably if it encounters an obstacle. Your door opens and closes quietly and smoothly with the soft start and soft stop.

Our elegant hand transmitters allow you to open your gate from your car as easily as you would operate a TV. You can also operate your door using stationary control elements, such as a radio code switch or radio finger-scan.



More information can be found in the "Garage door and entrance gate operators" brochure.





SupraMatic 4

Supra-fast door opening and smart additional functions

- 75% faster opening speed* up to 25 cm/s**
- Smart operation with the BlueSecur app
- Convenient garage ventilation
- Up to 3 to 5 times*** brighter LED lighting
- Extremely easy programming thanks to 2 x 7-segment display
- High-quality stainless steel operator cover
- Networked with Smart Home systems via the standard HCP interface
- Low power consumption in standby below 1 watt



As standard with two 4-button hand transmitters HSE 4 BS, textured surface black with chrome caps

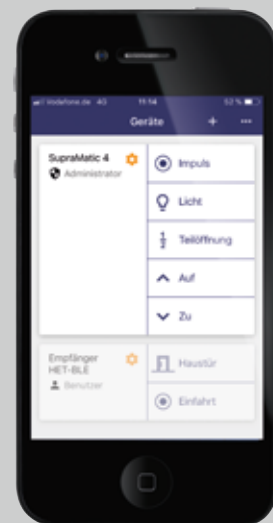

Garage door operators	SupraMatic E	SupraMatic P
Bluetooth receiver	Integrated, can be switched on and off	Integrated, can be switched on and off
HCP bus connection	Integrated	Integrated
Cycles per day / hour	25 / 10	50 / 10
Pull and push force	650 N	750 N
Peak force	800 N	1000 N
Max. opening speed	25 cm/s**	25 cm/s**
Lighting	20 LEDs	30 LED chase light
Max. door width	5500 mm	6000 mm
Max. door surface	13.75 m ²	15 m ²

Standard Bluetooth receiver for smartphone operation using the Hörmann BlueSecur app

* in comparison to the ProMatic series 3

** Up to 7.5 m² door leaf surface for sectional garage door with SupraMatic E, up to 9 m² door leaf surface with SupraMatic P, up to max. 22 cm/s for larger door surfaces

*** 3 times brighter with the SupraMatic E or 5 times brighter with the SupraMatic P in comparison to the ProMatic series 3

ProMatic 4

Premium quality at an attractive price

- 40% faster opening speed* up to 20 cm/s
- Convenient garage ventilation
- Up to 2 times* brighter LED lighting
- Networked with Smart Home systems via the standard HCP interface
- Low power consumption in standby below 1 watt



BiSecur
As standard with two 4-button hand transmitters HSE 4 BS, textured surface black with plastic caps

Garage door operators	ProMatic 4	ProMatic 2 Akku
Bluetooth receiver	Optional (HET-BLE)	
HCP bus connection	Integrated	
Cycles per day / hour	25 / 10	5 / 2
Pull and push force	600 N	350 N
Peak force	750 N	400 N
Max. opening speed	20 cm/s	13 cm/s
Lighting	10 LEDs	1 LED light
Max. door width	5000 mm	3000 mm
Max. door surface	11.25 m ²	8 m ²

ProMatic 2 Akku for garages without a power connection



ProMatic 2 Akku with solar module



Hand transmitter HS 5 BS

4 button functions, plus query button,

- 1 High-gloss surface black or white
- 2 Textured surface matt black

Hand transmitter HS 4 BS

4 button functions,

- 3 Textured surface matt black

Hand transmitter HS 1 BS

1 button function,

- 4 Textured surface matt black



Hand transmitter HSE 1 BS

1 button function, including eyelet for key ring

- 5 Textured surface matt black

Hand transmitter HSE 4 BS

4 button functions, incl. eyelet for key ring

- 6 Textured surface matt black with chrome or plastic caps

2 button functions, incl. eyelet for key ring



- 7 High-gloss surface with chrome caps in the colours:

Black, White, Anthracite Grey, Frozen Grey, Classic Grey, Carbon, Silver

■ **NEW** from autumn 2020

(Shown from left)

8 Hand transmitter HSD 2-A BS

Aluminium look, 2 button functions, can also be used as a key ring

9 Hand transmitter HSP 4 BS

4 button functions, with button lock-out incl. key ring

10 Hand transmitter HSZ 1 BS

1 button function, for insertion in vehicle cigarette lighter





Radio code switch FCT 3 BS
For 3 functions, with illuminated buttons, recessed and surface-mounted fitting possible, plastic housing in Light grey 7040 (also available with 10 functions and hinged cover, painted in White aluminium RAL 9006)



Transponder key switch TTR 1000-1
For 1 function, for 1000 teachable keys, 1 key and 1 card in scope of delivery (more on request), zinc die-cast housing in White aluminium RAL 9006



Radio finger-scan FFL 25 BS
For 2 functions and up to 25 fingerprints with hinged cover, recessed and surface-mounted fitting possible, plastic housing painted in White aluminium RAL 9006



Code switch CTP 3-1
For 3 functions, with illuminated lettering and touch-sensitive black surface, zinc die-cast housing in White aluminium RAL 9006



Radio internal push button FIT 5 BS
4 button functions plus query button, plastic housing in Pure white RAL 9010



Code switch CTV 3-1
For 3 functions, particularly robust with metal keypad, zinc die-cast housing in White aluminium RAL 9006 with stainless steel panel



Radio internal push button FIT 2-1 BS
For 2 functions, connection option for max. 2 control elements via cable, e.g. key switch, plastic housing in Pure white RAL 9010



Finger-scan FL 150
For 2 functions, control via fingerprint, up to 150 savable fingerprints, zinc die-cast housing in White aluminium RAL 9006 with stainless steel panel



Internal push button IT 1b-1
Large, illuminated button for convenient opening of the door, plastic housing in Pure white RAL 9010



Key switch 1 STUP 50
2 STAP 50
In a recessed version and surface-mounted version, including 3 keys, zinc die-cast housing in White aluminium RAL 9006 with stainless steel panel

More control elements can be found in the "Garage door and entrance gate operators" brochure

Optimum ventilation of the garage can effectively prevent mould

It is very important to ventilate the garage regularly; especially if insulated garage doors are fitted. Ventilation is achieved by folding down the top section (optional equipment) to prevent dirt, leaves or small animals from entering the garage. An additional climate sensor, which automatically regulates ventilation, is recommended for energy-efficient ventilation.





1

Ventilation slot on the topmost section 1

The optional folding roller bracket means that you only open the top section of your door to ventilate the garage. The bottom door section remains sealed on the ground, thus offering protection against small animals or leaves. The ventilation slot is adjusted using the “ventilation” operator function on doors with an operator*.

The folding roller bracket is optionally available on all sectional garage doors LPU 67 Thermo* and LPU 42* with operator and can be retrofitted on all sectional garage doors LPU 42* with operator SupraMatic or ProMatic (from year of manufacture 2012).



2

Climate sensor HKSI for automatic garage ventilation 2

The climate sensor** monitors humidity in the garage and regulates the ventilation. If humidity is too high, the door is automatically opened using the “ventilation” operator function and then automatically closed again once humidity is adjusted***.

For optimum operation, the temperature range in which the door does not open (e.g. if there is a risk of frost in the garage), the operating times (e.g. overnight shut-off) and opening times (e.g. max. 2 hours per ventilation) can be adjusted.

The optional external sensor HKSA 3 additionally measures the humidity outside and prevents the door from opening in case of high humidity levels. An on-site fan can also be installed for fast and effective ventilation.



3

* Only track application N, L, Z, not possible for doors with wicket door

** Available for the operators SupraMatic 4 (from 10.2019), SupraMatic 3 (from 07.2013, Index C), ProMatic 4 (from 10.2019) and WA 300 S4 (from 01.2014, Index D)

*** A photocell is required on doors without ventilation slot if the door closing edge is 30 mm or more above the floor in the ventilation position



Take a look at the video “Automatic garage ventilation” at: www.hormann.co.uk/videos

Out with the old, in with the new

At some point it is simply time to modernise your garage door. Hörmann can provide you with an attractive and appropriate solution for any fitting situation. Inexpensive standard sizes, especially created for modernisation, will save you money and make it possible to install your new sectional door faster. Your Hörmann partner also provides you with a complete package of services:

- Qualified consultation
- Measurement on site
- Professional fitting
- Removal and environmentally-friendly disposal



Your Hörmann partner would be pleased to advise you on-site.





HÖRMANN
Tore • Türen • Zargen • Antriebe

GT JA 19

Standard fitting **1**

Ideally, the available garage has at least 100 mm of clearance in the lintel area (at least 115 mm for doors with operator) and a 90 mm sideroom. The frame can then be screwed directly into the wall behind the opening.

Hörmann sectional doors come with all the necessary fitting materials.



Special anchor for frame side fixing

The sectional door frame can be fitted to the side wall of the garage with Hörmann's optional, universally applicable anchors. Irregularities in the wall can be easily compensated, leaving the reveal intact.

2 Fitting with up to 35 mm wall spacing

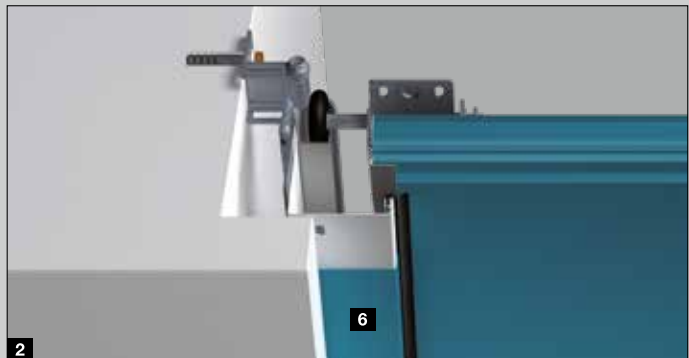

3 Fitting with thermal insulation composite system



4 Fitting with angled or irregular side wall

5 Fitting with non-load-bearing facades (facing brick or thermal insulation) with at least 90 mm and max. 125 mm sideroom

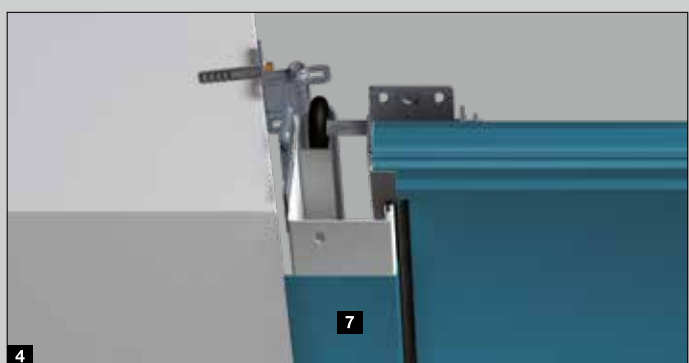

Frame covering in the colour of the door

At Hörmann, side frames are delivered in Woodgrain white as standard. With an optional frame covering that matches the door sections' surface finish and colour or decor, your door will become even more beautiful. Now you can enjoy the identical view of door sections and frame. For Duragrain doors, we optionally supply the frame cladding in a colour that matches the decor or in RAL to choose on request. Two different widths make it possible to cover the side frame for different fitting situations. The 55 mm wide frame covering is easy to fit using the standard adhesive pads.

6 55 mm wide frame covering for fitting behind the opening, with little sideroom (< 90 mm)



7 90 mm wide frame covering for fitting in the opening, flush with the wall



Fascia panels **1**

For greater distances between the side wall or ceiling and the door frame, the gap is sealed with panels matching the door sections. This creates a harmonious overall impression because the door style continues over the frame. Fascia panels are available for all door styles, each in the same surface finish and colour or decor of the door section, and also with design elements.

Fascia frame set for lintel and side wall

A door in an inexpensive standard or modernisation size can be fitted in the opening. The remaining gap between the lintel and top door section or side wall and side frame (max. 35 mm) is covered using an optional 95 mm wide fascia frame set for fitting in the reveal **2** or 125 mm wide fascia frame set for fitting in front of the reveal **4**. This set comes with fascia panels in the surface finish and colour or decor of the door sections, end caps and fixing materials. For Duragrain doors, we supply the panel frame set in a colour that matches the decor or in RAL to choose on request.

For the surface finishes Woodgrain, Sandgrain, Silkgrain and Decograin, our standard fascia panels **3** match the surface finish and colour or decor of the door. For Duragrain doors, the fascia panel comes as standard in Woodgrain, Traffic white, or optionally in a colour matching the decor or in RAL to choose. The side frame is additionally covered with an optional frame cladding **5** (see page 80 for details).

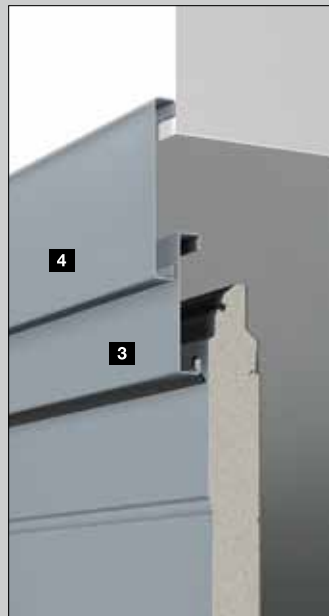

Fascia panels **1**

The fascia panel for **standing fitting behind the opening is supplied with a height of 95 mm as standard**. The panel is also available with a height of 125 mm on request. For the surface finishes Woodgrain, Sandgrain, Silkgrain and Decograin, our fascia panels always match the door surface finish and colour or decor of the door and can thus be visibly mounted in the opening. For Duragrain doors, we supply the panels in Woodgrain, Traffic white, as standard. The fascia panel optionally comes in a colour matching the decor or in RAL to choose.



Double-skinned fascia panel **2**

A matching, double-skinned fascia panel for fitting in the opening covers a larger gap between the ceiling and fascia panel. It is available for all surface finishes and colours or decors. Glazings are also possible after technical clarification. This panel can be optionally supplied as an aluminium light strip.



Flush-fitting fascia panels **3**

For LPU 42 doors, a flush-fitting fascia panel is **the most elegant solution for an invisible transition** between the panel and door leaf. When the door is closed, the top door section **4** is flush with the panel **5**. It is available for all door styles in all surface finishes and colours or decors (panelled on request).



Retrofit fascia set **6**

Unattractive gaps and broken masonry in the lintel and reveal can be covered easily and neatly with the optional retrofit fascia. Additional brickwork and plastering work are no longer required. The set with 3 fascia panels (each 3 metres long) is available in all surface finishes and colours or decors to match the door. For Duragrain doors, we supply the panels in a colour that matches the decor or in RAL to choose on request.





Frame support set ■ NEW 1

The plastic profile is fitted between the frame and brickwork. In the case of damp exterior walls, this prevents the transfer of moisture to the frame and effectively prevents the formation of rust.



Recess set 2

When removing an old up-and-over door and fitting a new LPU 42 sectional door, a time-consuming process is often necessary to remove the threshold rail or straighten the ground. **With the recess set, these steps can be omitted as the sectional door is positioned in front of the threshold rail.** The set consists of a compensation profile 3 and special door hardware. The frame must be shortened by 25 mm if the set is used. This can either be ordered in the desired dimensions or shortened on site.



Wind threshold 4

The profile is simply fitted to the floor and seals off the door bottom edge additionally. It **prevents the penetration of water** across the full door width. The low height ensures barrier-free access.



Compensation set for uneven floors ■ NEW

The **adjustable bottom profile 5** compensates the bottom edge of the door leaf up to a height difference of 20 mm. The **set for frame compensation** consists of 2.5 mm-thick plastic plates 6, which are positioned to fit perfectly under the frame shoes.

For more detailed information, please see the technical manual or contact your Hörmann partner.

SIZES AND FITTING DATA

Size range LPU 67 Thermo, LPU 42, LTE 42, ART 42, ART 42 Thermo

Standard and special sizes ¹⁾

Grid height (RM)	Clear frame dimension (LZ)											Interior garage dimension (GIM)																									
	2250	2375	2500	2625	2750	3000	3250	3500	3750	4000	4250	4500	4750	5000	5250	5500	6000	2430	2555	2680	2805	2930	3180	3430	3680	3930	4180	4430	4680	4930	5180	5430	5680	6180			
3000						●																															
2875																																					
2750			●		●																																
2625	■	■	■	■	■	■	■	■	■	■	■	■	■	■	■	■	■	■	■	■	■	■	■	■	■	■	■	■	■	■	■	■	■	■	■	■	■
2500	■	■	■	■	■	■	■	■	■	■	■	■	■	■	■	■	■	■	■	■	■	■	■	■	■	■	■	■	■	■	■	■	■	■	■	■	■
2375	■	■	■	■	■	■	■	■	■	■	■	■	■	■	■	■	■	■	■	■	■	■	■	■	■	■	■	■	■	■	■	■	■	■	■	■	■
2250	■	■	■	■	■	■	■	■	■	■	■	■	■	■	■	■	■	■	■	■	■	■	■	■	■	■	■	■	■	■	■	■	■	■	■	■	■
2125	■	■	■	■	■	■	■	■	■	■	■	■	■	■	■	■	■	■	■	■	■	■	■	■	■	■	■	■	■	■	■	■	■	■	■	■	■
2080	■	■	■	■	■	■	■	■	■	■	■	■	■	■	■	■	■	■	■	■	■	■	■	■	■	■	■	■	■	■	■	■	■	■	■	■	■
2000	■	■	■	■	■	■	■	■	■	■	■	■	■	■	■	■	■	■	■	■	■	■	■	■	■	■	■	■	■	■	■	■	■	■	■	■	■
1875	■	■	■	■	■	■	■	■	■	■	■	■	■	■	■	■	■	■	■	■	■	■	■	■	■	■	■	■	■	■	■	■	■	■	■	■	■

Modernisation sizes ²⁾

Grid height (RM)	LZ				GIM			
	2190	2315	2440	2940	2370	2495	2620	3120
2205		●	●					
2080	●	●	●	●				
1955	●	●	●					

- = Available standard sizes depending on the door type and door style, intermediate sizes available as special sizes
- ¹⁾ LPU 67 Thermo is only available in special sizes up to 5000 mm door width, SPU F42 Plus up to door sizes 7000 x 5000 mm, ART 42 / ART 42 Thermo up to 5500 x 2250 mm
- ²⁾ Not available for panel styles with Decograin surface finish and solid timber doors

Track application Z for LPU 42 Silkgrain, LPU 67, ART 42, ART 42 Thermo
 Track application Z
 Track application N

Ceiling heights and clear passage heights

Grid height (RM)	Track application Z		Track application N		Track application L	
	Min. DE*	LDH**	Min. DE*	LDH	Min. DE*	LDH***
With operator						
3000			3210	3000	3115	2970
2875			3085	2875	2990	2845
2750			2960	2750	2865	2720
2625	2740	2595	2835	2625	2740	2595
2500	2615	2470	2710	2500	2615	2470
2375	2490	2345	2585	2375	2490	2345
2250	2365	2220	2460	2250	2365	2220
2125	2240	2095	2335	2125	2240	2095
2000	2115	1970	2210	2000	2115	1970
1875	1990	1845	2085	1875	1990	1845
With manual operation						
3000			3210	2950	3100	2900
2875			3085	2825	2975	2775
2750			2960	2700	2850	2650
2625	2725	2545	2835	2575	2725	2525
2500	2600	2420	2710	2450	2600	2400
2375	2475	2295	2585	2325	2475	2275
2250	2350	2170	2460	2200	2350	2150
2125	2225	2045	2335	2075	2225	2025
2000	2100	1920	2210	1950	2100	1900
1875	1975	1795	2085	1825	1975	1775

Grid height (RM)	Track application Z	
	Min. DE**	LDH
With operator		
2205	2320	2175
2080	2195	2050
1955	2070	1925
With manual operation		
2205	2305	2125
2080	2180	2000
1955	2055	1875

* With ThermoFrame and operator: see fitting data
 ** LPU 67 Thermo: LDH – 55 mm
 *** LPU 42: LZ > 3010 mm = LDH – 80 mm LPU 67 Thermo: LZ < 3000 mm = LDH – 55 mm, LZ > 3010 mm = LDH – 105 mm

Vertical views (with operator)

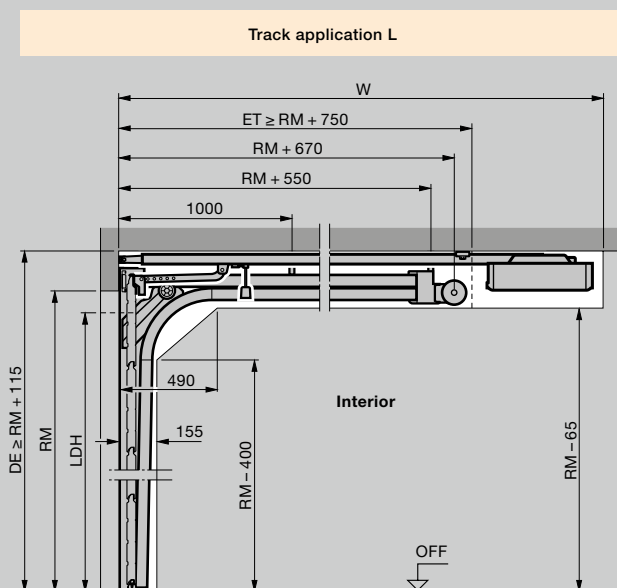
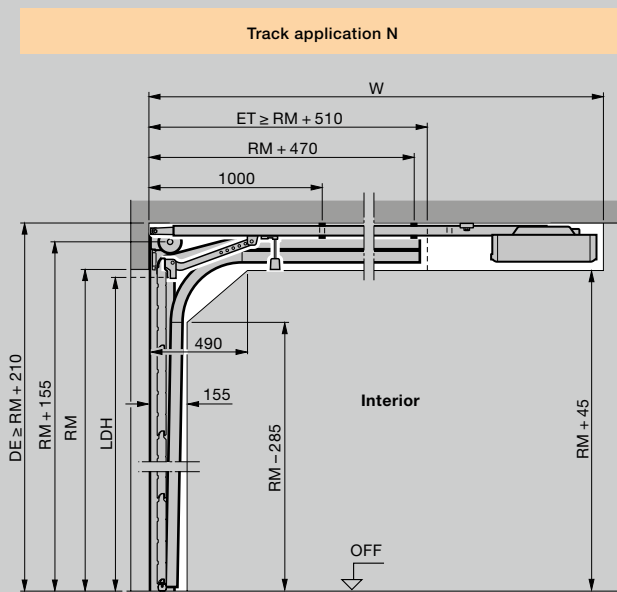
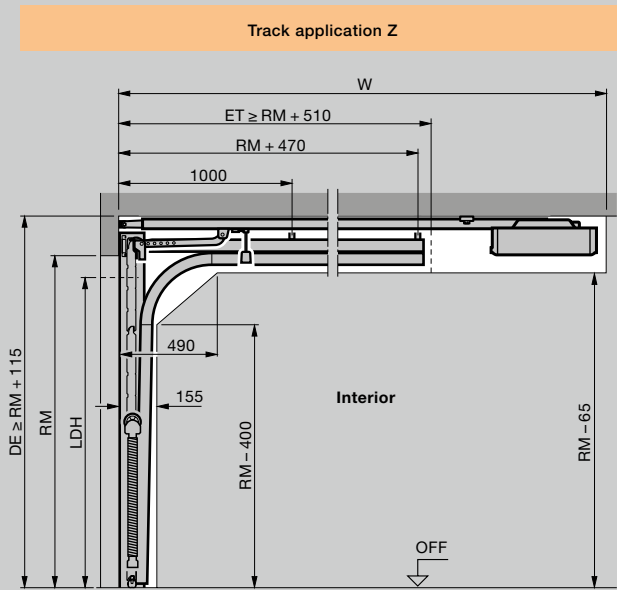

Horizontal view

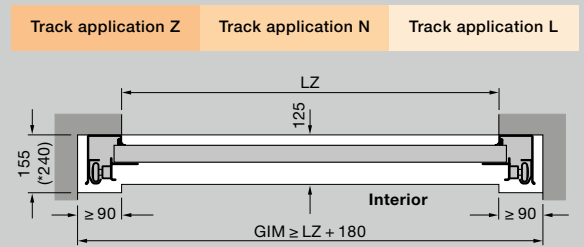

Fitting with track applications Z, N, L

Overall length operators (W)	Track application Z	Track application N	Track application L
Doors with operator			
	2125 (K)	3200	3200*
	2250 (K)		3200**
Max. door height	2375 (M)	3450	3450*
	2500 (M)		3450**
	2625 (L)	4125	
	3000 (L)		4125

* Max. door height only for LPU 67 Thermo

** Max. door height only for LPU 42, LTE 42

Explanations

Operator booms

- K Short boom
- M Medium boom
- L Long boom

Ordering sizes

- LZ Clear frame dimension
- RM Grid height
- DE Ceiling height
- W Overall length with operator
- LDH Clear passage height
- GIM Inside garage dimension
- ET Distance back

Notice:

The operator should be fitted 40 mm higher for dark coloured doors which are exposed to the sun.

For track applications such as low headroom or high-lift track applications as well as more detailed information, please see the technical manual or contact your Hörmann partner.

SIZES AND FITTING DATA FOR SIDE DOORS

Solid timber and steel side doors – horizontal views

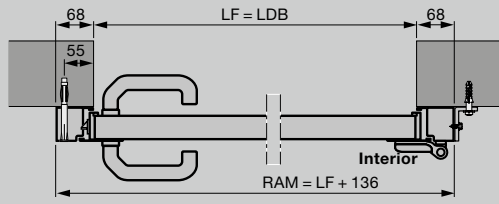

Side door with aluminium block frame, profile type 1
Fitting behind the opening

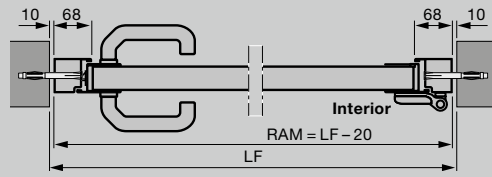

Side door with aluminium block frame, profile type 2
Fitting in the opening

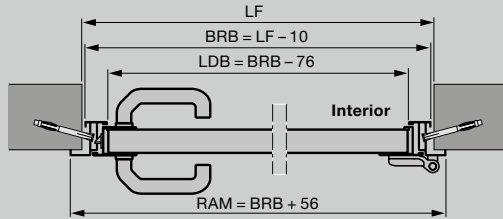

Side door with aluminium corner frame, profile type 1
or 2
Internal fitting

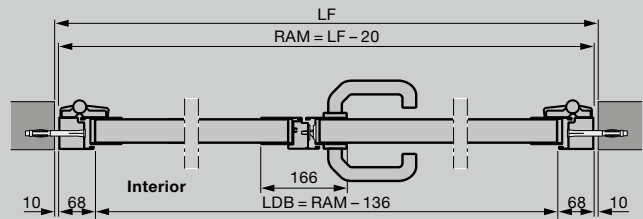

Double-leaf side door with aluminium block frame, profile type 2
Fitting in the opening

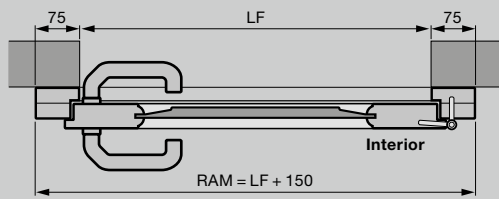

Solid timber side door
Fitting behind the opening

- Double-leaf side door with asymmetrical division
- Double-leaf side door opening inwards and outwards

Solid timber and steel side doors – vertical views

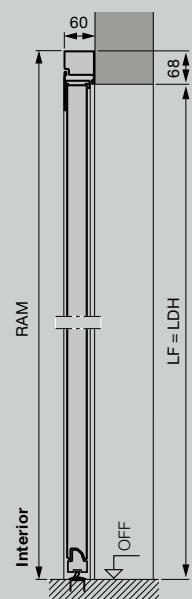

Side door with aluminium
block frame, profile type 2
Fitting behind the opening

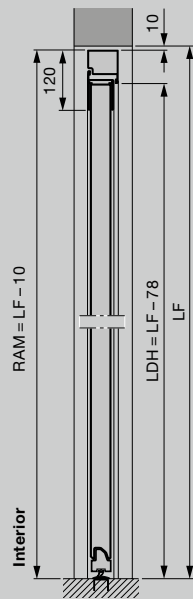

Side door with aluminium
block frame, profile type 2
Fitting in the opening

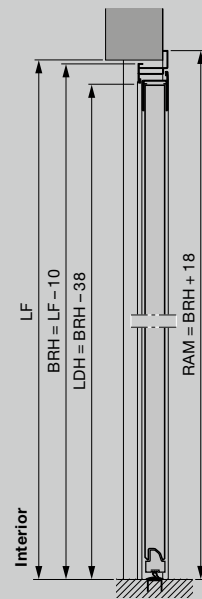

Side door with aluminium
corner frame, profile type 2
External fitting

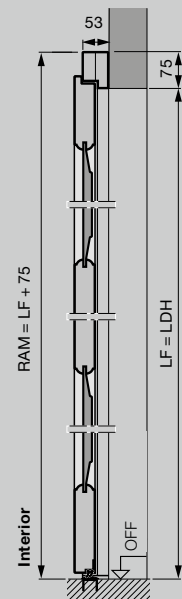

Solid timber side door
Fitting behind the opening

Steel side doors

Profile type 1 (fitting behind the opening) with S-, M-, L-ribbing, S-panelled, block frame

Structural opening	Ordering size = RAM	Lever height* from OFF	Door section height B
855 – 875 × 1990 – 2000	990 × 2058	955	500
855 – 875 × 2115 – 2125	990 × 2183	1010	531
980 – 1000 × 1990 – 2000	1115 × 2058	955	500
980 – 1000 × 2115 – 2125	1115 × 2183	1010	531

Profile type 2 (fitting behind the opening) with S-, M-, L-, D-, T-ribbing, S-panelled, block frame

Structural opening	Ordering size = RAM	Lever height* from OFF	Door section height B
855 – 875 × 1990 – 2000	990 × 2058	1050	500
855 – 875 × 2115 – 2125	990 × 2183	1050	531
980 – 1000 × 1990 – 2000	1115 × 2058	1050	500
980 – 1000 × 2115 – 2125	1115 × 2183	1050	531

Profile type 2 (fitting in the opening) with S-, M-, L-, D-, T-ribbing, block frame

Structural opening	Ordering size = RAM	Lever height* from OFF	Door section height B
875 × 2000	855 × 1990	1050	500
875 × 2125	855 × 2115	1050	531
1000 × 2000	980 × 1990	1050	500
1000 × 2125	980 × 2115	1050	531

Profile type 1 (only opening inwards, internal fitting) with S-, M-, L-ribbing, S-panelled, corner frame

Ordering size = BRM	Lever height* from OFF	Door section height B
875 × 2000	955	500
875 × 2125	1010	531
1000 × 2000	955	500
1000 × 2125	1010	531

Profile type 2 (internal or external fitting) with S-, M-, L-, D-, T-ribbing, corner frame

Ordering size = BRM	Lever height* from OFF	Door section height B
875 × 2000	1050	500
875 × 2125	1050	531
1000 × 2000	1050	500
1000 × 2125	1050	531

Solid timber side doors

Ordering size = RAM	Structural opening	Lever height* from OFF
---------------------	--------------------	------------------------

Fitting behind the opening (S-, M-, L-ribbed, panelled)

1005 × 2190	855 – 875 × 2115 – 2125	1050
1130 × 2190	980 – 1000 × 2115 – 2125	1050

Fitting behind the opening (style 401, 403, 404, 405)

1130 × 2190	980 – 1000 × 2115 – 2125	1050
-------------	--------------------------	------

Dimensions in mm

Explanations

- P1 Profile type 1 (narrow leaf frame)
P2 Profile type 2 (wide leaf frame)

- LDB Clear passage width
LDH Clear passage height
RAM Overall frame dimension
LF Structural opening
BRM Nominal size
BRB Nominal size – width
BRH Nominal size – height
OFF Finished floor level

Special sizes

Single-leaf side doors on request

Double-leaf side doors:

1330 – 2500 × 1960 – 2558 mm

* You can find the lever heights for special sizes in the technical manual.

For more detailed information, please see the technical manual or contact your Hörmann partner.



HÖRMANN

Experience Hörmann quality in new construction and modernisation

Hörmann provides an excellent basis for comprehensive planning. Carefully matched solutions offer you the very best in perfectly designed products for every area.

- **Garage doors**

Optimally match your personal architectural style: up-and-over or sectional doors made of steel or timber.

- **Gate and door operators**

Enjoy extra convenience and break-in-resistant security with Hörmann operators for garage doors and entrance gates. You can profit from the convenience of Hörmann door operators in your residential space as well.

- **Entrance doors**

Our comprehensive entrance door ranges include models that fit almost every need and requirement.

- **Residential internal doors**

Our high-quality timber and glass doors give your home an extra level of comfort and integrate harmoniously into the overall appearance of your home.

- **Steel doors**

Sturdy doors for your entire home, from basement to roof.

- **Frames**

Choose from our comprehensive range of products for new construction, expansion and modernisation.



Garage doors and entrance gate operators



Residential internal doors and door operators



Steel doors

Hörmann: Quality without Compromise



Hörmann KG Amshausen, Germany



Hörmann KG Antriebstechnik, Germany



Hörmann KG Brandis, Germany



Hörmann KG Brockhagen, Germany



Hörmann KG Dissen, Germany



Hörmann KG Eckelhausen, Germany



Hörmann KG Freisen, Germany



Hörmann KG Ichttershausen, Germany



Hörmann KG Werne, Germany



Hörmann Alkmaar B.V., Netherlands



Hörmann Legnica Sp. z o.o., Poland



Hörmann Beijing, China



Hörmann Tianjin, China



Hörmann LLC, Montgomery IL, USA



Hörmann Flexon LLC, Burgettstown PA, USA



Shakti Hörmann Pvt. Ltd., India

Hörmann is the only manufacturer worldwide that offers you a complete range of all major building products from one source. We manufacture in highly-specialised factories using the latest production technologies. The close-meshed network of sales and service companies throughout Europe, and activities in the USA and Asia, make Hörmann your strong partner for first-class building products, offering "Quality without Compromise".

GARAGE DOORS
OPERATORS
INDUSTRIAL DOORS
LOADING EQUIPMENT
HINGED DOORS
DOOR FRAMES